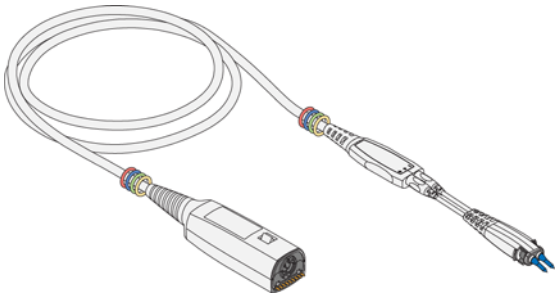


# Agilent 1130A-Series Differential and Single-Ended Probes



*User's Guide*



**Agilent Technologies**

## Notices

© Agilent Technologies, Inc. 2014

No part of this manual may be reproduced in any form or by any means (including electronic storage and retrieval or translation into a foreign language) without prior agreement and written consent from Agilent Technologies, Inc. as governed by United States and international copyright laws.

## Manual Part Number

01130-97006

## Edition

April 2014

Designed in USA

Agilent Technologies, Inc.

Oscilloscope Products Division

## Warranty

The material contained in this document is provided "as is," and is subject to being changed, without notice, in future editions. Further, to the maximum extent permitted by applicable law, Agilent disclaims all warranties, either express or implied, with regard to this manual and any information contained herein, including but not limited to the implied warranties of merchantability and fitness for a particular purpose. Agilent shall not be liable for errors or for incidental or consequential damages in connection with the furnishing, use, or performance of this document or of any information contained herein. Should Agilent and the user have a separate written agreement with warranty terms covering the material in this document that conflict with these terms, the warranty terms in the separate agreement shall control.

## Technology Licenses

The hardware and/or software described in this document are furnished under a license and may be used or copied only in accordance with the terms of such license.

## Restricted Rights Legend

If software is for use in the performance of a U.S. Government prime contract or subcon-

tract, Software is delivered and licensed as "Commercial computer software" as defined in DFAR 252.227-7014 (June 1995), or as a "commercial item" as defined in FAR 2.101(a) or as "Restricted computer software" as defined in FAR 52.227-19 (June 1987) or any equivalent agency regulation or contract clause. Use, duplication or disclosure of Software is subject to Agilent Technologies' standard commercial license terms, and non-DOD Departments and Agencies of the U.S. Government will receive no greater than Restricted Rights as defined in FAR 52.227-19(c)(1-2) (June 1987). U.S. Government users will receive no greater than Limited Rights as defined in FAR 52.227-14 (June 1987) or DFAR 252.227-7015 (b)(2) (November 1995), as applicable in any technical data.

## Instrument Markings



The CE mark is a registered trademark of the European Community. ISM GRP 1-A denotes the instrument is an Industrial Scientific and Medical Group 1 Class A product. ICES/NMB-001 indicates product compliance with the Canadian Interference-Causing Equipment Standard.



This product complies with the WEEE Directive (2002/96/EC) marking requirements. The affixed label indicates that you must not discard this electrical/electronic product in domestic household waste. Product Category: With reference to the equipment types in the WEEE Directive Annex I, this product is classed as a "Monitoring and Control instrumentation" product. Do not dispose in domestic household. To return unwanted products, contact your local Agilent office, or refer to [www.agilent.com](http://www.agilent.com) for more information.



This symbol indicates the Environmental Protection Use Period (EPUP) for the product's toxic substances for the China RoHS requirements.

## Safety Notices

**CAUTION.** A **CAUTION** notice denotes a hazard. It calls attention to an operating procedure, practice, or the like that, if not correctly performed or adhered to, could result in damage to the product or loss of important data. Do not proceed beyond a **CAUTION** notice until the indicated conditions are fully understood and met.

**WARNING.** A **WARNING** notice denotes a hazard. It calls attention to an operating procedure, practice, or the like that, if not correctly performed or adhered to, could result in personal injury or death. Do not proceed beyond a **WARNING** notice until the indicated conditions are fully understood and met.

# Contents

## 1 Getting Started

- Introduction 8
- Supplied Accessories 12
- Optional Probe Heads with Supplied Accessories 13
- Optional E2668A Single-Ended Connectivity Kit 17
- Optional E2669A Differential Connectivity Kit and Accessories 19
- Using the Velcro Dots 21
- Other Available Accessories 22
- Probe Handling 30
- Using Offset With InfiniiMax Active Probes 34
- Slew Rate Requirements for Different Technologies 36
- Safety Information 39
- Service 42

## 2 Using Probe Heads

- Recommended Configurations at a Glance 46
- Replacing Resistors on E2677A/9A Solder-In Probe Heads 71

## 3 Calibrating Probes

- Calibration for Solder-In and Socketed Probe Heads 78
- Calibration for Hand-held Browser Probe Heads 86

## 4 Characteristics and Specifications

- General 90
- Environmental 92
- Regulatory 93
- Probe Dimensions 94

## 5 1130A Performance Data Plots

- E2675A Differential Browser 96
- E2676A Single-Ended Browser 99
- E2677A Differential Solder-in Probe Head (Full BW) 102

E2677A Differential Solder-in Probe Head (Medium BW) 105  
E2678A Differential Socketed Probe Head (Full BW) 108  
E2678A Differential Socketed Probe Head with Damped Wire Accessory 111  
E2679A Single-Ended Solder-in Probe Head (Full BW) 115  
E2679A Single-Ended Solder-in Probe Head (Medium BW) 118

**6 1131A Performance Data Plots**

E2675A Differential Browser 122  
E2676A Single-Ended Browser 125  
E2677A Differential Solder-in Probe Head (Full BW) 128  
E2677A Differential Solder-in Probe Head (Medium BW) 131  
E2678A Differential Socketed Probe Head (Full BW) 134  
E2678A Differential Socketed Probe Head with Damped Wire Accessory 137  
E2679A Single-Ended Solder-in Probe Head (Full BW) 141  
E2679A Single-Ended Solder-in Probe Head (Medium BW) 144

**7 1132A Performance Data Plots**

E2675A Differential Browser 148  
E2676A Single-Ended Browser 151  
E2677A Differential Solder-in Probe Head (Full BW) 154  
E2677A Differential Solder-in Probe Head (Medium BW) 157  
E2678A Differential Socketed Probe Head (Full BW) 160  
E2678A Differential Socketed Probe Head with Damped Wire Accessory 163  
E2679A Single-Ended Solder-in Probe Head (Full BW) 167  
E2679A Single-Ended Solder-in Probe Head (Medium BW) 170

**8 1134A Performance Data Plots**

E2675A Differential Browser 174  
E2676A Single-Ended Browser 177  
E2677A Differential Solder-in Probe Head (Full BW) 180  
E2677A Differential Solder-in Probe Head (Medium BW) 183  
E2678A Differential Socketed Probe Head (Full BW) 186  
E2678A Differential Socketed Probe Head with Damped Wire Accessory 189  
E2679A Single-Ended Solder-in Probe Head (Full BW) 193  
E2679A Single-Ended Solder-in Probe Head (Medium BW) 196  
N5380B SMA Probe Head 199

**9 Performance Verification**

- Using the 8720ES VNA successfully 203
- Procedure 204
- Performance Test Record 213

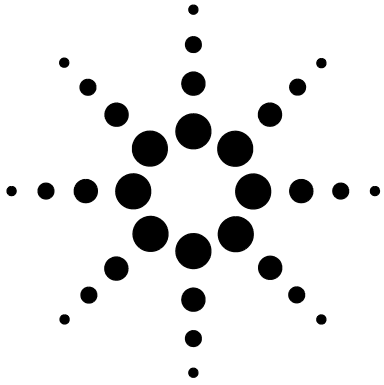
**10 SPICE Models**

- SPICE Model for Differential Probe Heads 217
- SPICE Model for Single-Ended Probe Heads 219
- SPICE Deck and Measured/Modeled Data Matching 220

**11 Replacement Parts**

- E2675A Differential Browser Probe Head 232
- E2677A Differential Solder-In Probe Head 232
- E2678A Differential Socketed Probe Head 233
- E2679A Single-Ended Solder-in Probe Head 234
- Other Accessories 234

## Contents



# 1 Getting Started

|   |    |
|---|----|
| Introduction  | 8  |
| Supplied Accessories  | 12 |
| Optional Probe Heads with Supplied Accessories                | 13 |
| Optional E2668A Single-Ended Connectivity Kit                 | 17 |
| Optional E2669A Differential Connectivity Kit and Accessories | 19 |
| Other Available Accessories                                   | 22 |
| Probe Handling  | 30 |
| Using Offset With InfiniiMax Active Probes                    | 34 |
| Using the Velcro Dots   | 21 |
| Slew Rate Requirements for Different Technologies             | 36 |
| Safety Information  | 39 |
| Service   | 42 |

The 1130/1/2/4A InfiniiMax active probes are designed for probing differential and single-ended high-frequency signals. The probes are compatible with the Infiniium AutoProbe Interface which completely configures the Infiniium series of oscilloscopes for the probes.

---

**WARNING**

---

Before using the probe, refer to **“Safety Information”** on page 39.

---

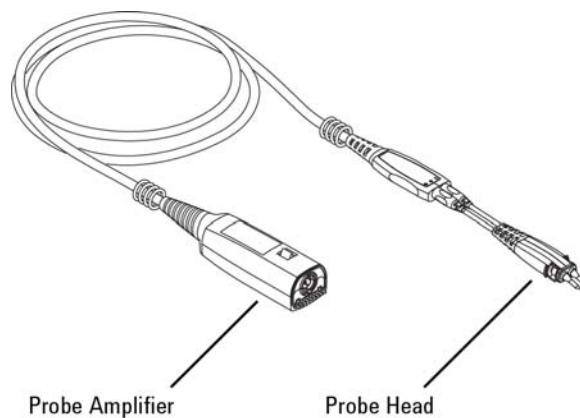
**CAUTION**

---

Before using the probes, refer to **“Probe Handling”** on page 30.

## Introduction

Before you can use the probe, you must connect one of the available probe heads to an 1130/1/2/4A probe amplifier. The available probe heads are documented in [Chapter 2](#), “Using Probe Heads”.



**Figure 1** Probe Amplifier with Attached Head

### Probe Heads

[Figure 2](#) on page 9 shows the available probe heads and accessories. The InfiniiMax I probe heads are designed specifically for the 1130/1/2/4A probe amplifiers. The InfiniiMax II probe heads are designed for 1168/9A probe amplifiers, but can also be used with the 1130/1/2/4A probe amplifiers.

Differential probe heads offer easy measurement of differential signals and greatly improve the measurement of single-ended signals. Single-ended probe heads offer extremely small size for probing single-ended signals in confined spaces.

Each available InfiniiMax I probe head is documented in [Chapter 2](#), “Using Probe Heads”.



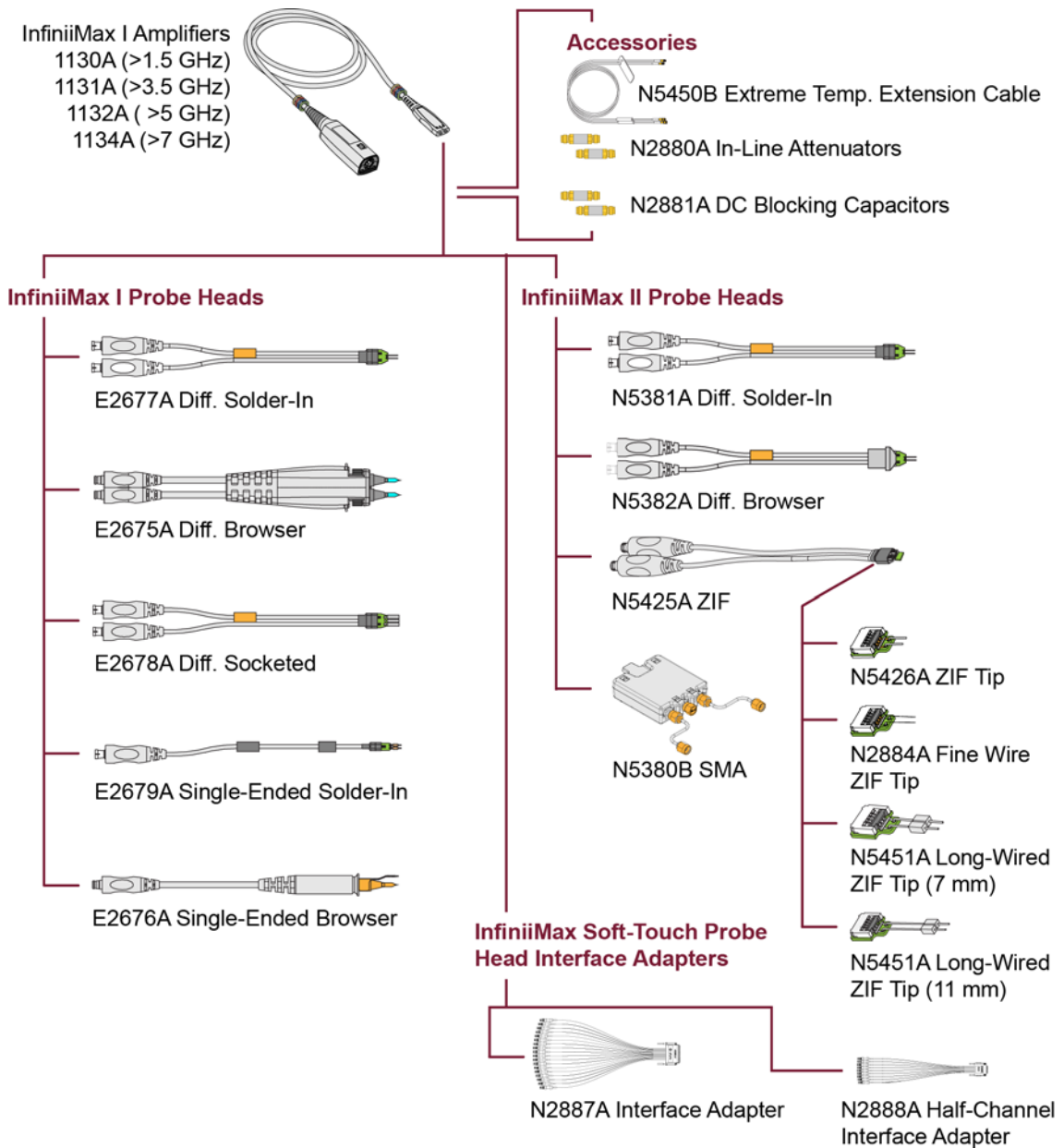


Figure 2 Available Probe Heads

## Compatible Oscilloscopes

### Is Your Oscilloscope Software Up-to-Date?

Agilent periodically releases software updates to support your probe, fix known defects, and incorporate product enhancements. To download the latest firmware, go to [www.agilent.com](http://www.agilent.com) and search for your oscilloscope's topic. Click on the "Drivers, Firmware & Software" tab.

**Table 1 Compatible Oscilloscopes**

| Oscilloscope                       | Adapter Required |
|------------------------------------|------------------|
| <b>Infiniium Oscilloscopes</b>     |                  |
| 90000 X-, and Q-Series             | N5442A           |
| 90000A Series                      | none             |
| 86100C/D Series                    | N1022A/B         |
| 9000 H-Series                      | none             |
| 9000A-Series                       | none             |
| 8000A-Series                       | none             |
| <b>InfiniiVision Oscilloscopes</b> |                  |
| 7000A Series                       | none             |
| 6000A Series (350 MHz — 1 GHz)     | none             |
| 5000A Series                       | none             |
| 4000 X-Series                      | none             |
| 3000 X-Series                      | none             |

### Cleaning the probe

If the probe requires cleaning, disconnect it from the oscilloscope and clean it with a soft cloth dampened with a mild soap and water solution. Make sure the probe is completely dry before reconnecting it to the oscilloscope.

### Channel Identification Rings

When multiple probes are connected to the oscilloscope, use the channel identification rings to associate the channel inputs with each probe. Place one colored ring near the probe's channel connector and place an identical color ring near the probe head.

## Inspecting the Probe

- Inspect the shipping container for damage.  
Keep the damaged shipping container or cushioning material until the contents of the shipment have been checked for completeness and the probe has been checked mechanically and electrically.
- Check the accessories.
- If the contents are incomplete or damaged, notify your Agilent Technologies Sales Office.
- Inspect the probe. If there is mechanical damage or defect, or if the probe does not operate properly or pass calibration tests, notify your Agilent Technologies Sales Office.

If the shipping container is damaged, or the cushioning materials show signs of stress, notify the carrier as well as your Agilent Technologies Sales Office. Keep the shipping materials for the carrier's inspection. The Agilent Technologies office will arrange for repair or replacement at Agilent Technologies' option without waiting for claim settlement.

## Supplied Accessories

Figure 3 shows the accessories that are shipped with the 1130/1/2/4A probe amplifiers. The probe amplifiers do not come with a probe head *unless* selected at the time of order. Any head shown in Figure 2 on page 9 can be ordered at any time for any 1130/1/2/4A probes.

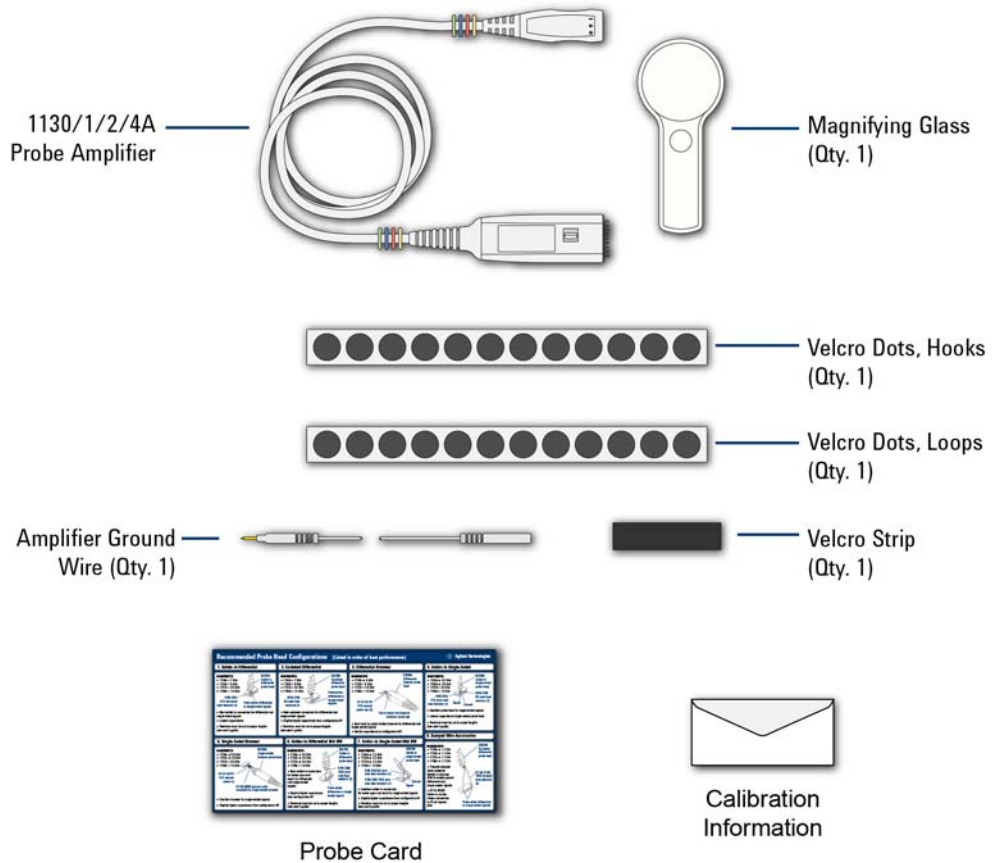
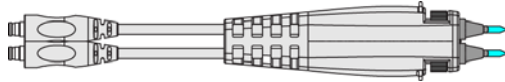


Figure 3 Accessories Supplied With the Probe Amplifier

## Optional Probe Heads with Supplied Accessories

The following optional probe heads (with their accessories) can be ordered at the same time as 1130/1/2/4A probe amplifiers. The E2669A and E2668A connectivity kits, described on [page 19](#) and [page 17](#) conveniently package multiple probe heads and their accessories.

### E2675A Differential Browser Probe Head



**Table 2** Supplied Accessories

| Description               | Qty Supplied | Part Number |
|---------------------------|--------------|-------------|
| Resistive tip (blue), 91Ω | 20           | 01131-62102 |
| Ergonomic handle          | 1            | 01131-43201 |

## 1 Getting Started

### Optional Probe Heads with Supplied Accessories

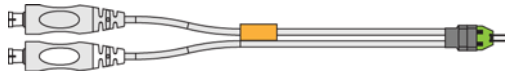
#### E2676A Single-Ended Browser Probe Head



**Table 3 Supplied Accessories**

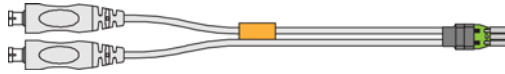
| Description                   | Qty Supplied | Part Number |
|-------------------------------|--------------|-------------|
| Resistive tip (blue), 91Ω     | 10           | 01131-62102 |
| Ground collar                 | 2            | 01130-60005 |
| Socketed ground lead 6 inches | 1            | E2676-21301 |
| Ergonomic handle              | 1            | 01130-43202 |

#### E2677A Differential Solder-In Probe Head



**Table 4 Supplied Accessories**

| Description                        | Qty Supplied | Part Number                           |
|------------------------------------|--------------|---------------------------------------|
| 91Ω resistor for full bandwidth    | 20           | 0700-2353<br><i>(not orderable)</i>   |
| 150Ω resistor for medium bandwidth | 10           | 0700-2350<br><i>(not orderable)</i>   |
| 91Ω resistor template              | 1            | 01131-94311<br><i>(not orderable)</i> |
| 150Ω resistor template             | 1            | 01131-94308<br><i>(not orderable)</i> |

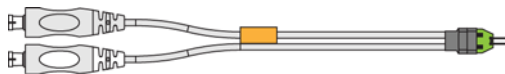
**E2678A Differential Socketed Probe Head****Table 5 Supplied Accessories**

| Description   | Qty Supplied | Part Number                           |
|---|--------------|---------------------------------------|
| 160 $\Omega$ damped wire accessory                                | 6            | 01130-21302                           |
| 82 $\Omega$ resistor for full bandwidth                           | 48           | 01130-81506<br><i>(not orderable)</i> |
| Socket for 25 mil (25/1000 inch) square pins, female on both ends | 4            | 01131-85201<br><i>(not orderable)</i> |
| 25 mil female socket w/20 mil round male pin on other end         | 4            | 01131-85202<br><i>(not orderable)</i> |
| Heatshrink socket accessory                                       | 4            | 01130-41101<br><i>(not orderable)</i> |
| Header adapter, 91 $\Omega$                                       | 2            | 01130-63201                           |
| 82 $\Omega$ resistor template                                     | 1            | 01131-94309                           |

## 1 Getting Started

### Optional Probe Heads with Supplied Accessories

#### E2679A Single-Ended Solder-In Probe Head



**Table 6 Supplied Accessories**

| Description                               | Qty Supplied | Part Number <sup>a</sup> |
|---|--------------|--------------------------|
| 91Ω resistor for full bandwidth           | 16           | 0700-2353                |
| 150Ω resistor for medium bandwidth        | 8            | 0700-2350                |
| 0Ω resistor for full and medium bandwidth | 24           | 0700-2348                |
| 91Ω resistor template                     | 2            | 01131-94311              |
| 150Ω resistor template                    | 2            | 01131-94308              |

*a Not orderable.*

#### N5425A ZIF Probe Head and N5426A ZIF Tip

There are no accessories supplied with the N5425A or N5426A.



N5425A ZIF

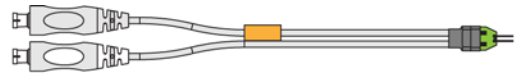
N5426A ZIF Tip



## Optional E2668A Single-Ended Connectivity Kit

The E2668A single-ended connectivity kit is an accessory that provides the three probe heads shown in Figure 4. A single-ended socket-tip probe head was not developed since it did not offer a significant size advantage. The kit can be ordered at the same time as 1130/1/2/4A probe amplifiers.

E2679A Single-Ended Solder-In (quantity 1)



E2678A Differential Socketed (quantity 1)



E2676A Single-Ended Browser (quantity 1)



Figure 4 E2668A Single-Ended Connectivity Kit (*not to scale*)

Table 7 Supplied Accessories (Sheet 1 of 2)

| Description                               | Qty Supplied | Used With |        |        | Part Number <sup>a</sup> |
|---|--------------|-----------|--------|--------|--------------------------|
|   |              | E2679A    | E2678A | E2676A |                          |
| E2679A Single-Ended Solder-In Head        | 1            |           | —      |        | —                        |
| E2678A Differential Socketed Head         | 1            |           | —      |        | —                        |
| E2676A Single-Ended Browser               | 1            |           | —      |        | —                        |
| 91Ω resistor for full bandwidth           | 16           | ✓         |        |        | 0700-2353                |
| 150Ω resistor for medium bandwidth        | 8            | ✓         |        |        | 0700-2350                |
| 0Ω resistor for full and medium bandwidth | 24           | ✓         |        |        | 0700-2348                |
| 91Ω resistor template                     | 2            | ✓         |        |        | 01131-94311              |
| 150Ω resistor template                    | 2            | ✓         |        |        | 01131-94308              |

**1 Getting Started**  
 Optional E2668A Single-Ended Connectivity Kit

**Table 7 Supplied Accessories (Sheet 2 of 2)**

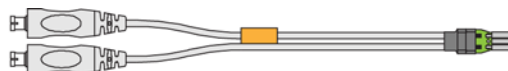
| Description   | Qty Supplied | Used With |        |        | Part Number <sup>a</sup> |
|---|--------------|-----------|--------|--------|--------------------------|
|   |              | E2679A    | E2678A | E2676A |                          |
| 160Ω damped wire accessory  | 6            |           | ✓      |        | 01130-21302              |
| 82Ω resistor for full bandwidth                                   | 48           |           | ✓      |        | 01130-81506              |
| Socket for 25 mil (25/1000 inch) square pins, female on both ends | 4            |           | ✓      |        | 01131-85201              |
| 25 mil female socket w/20 mil round male pin on other end         | 4            |           | ✓      |        | 01131-85202              |
| Heat shrink tubing for square-pin socket accessory                | 4            |           | ✓      |        | 01130-41101              |
| Header adapter, 91Ω   | 2            |           | ✓      |        | 01130-63201              |
| 82Ω resistor template   | 1            |           | ✓      |        | 01131-94309              |
| Resistive tip (blue), 91Ω   | 10           |           |        | ✓      | 01131-62102              |
| Ergonomic handle  | 1            |           |        | ✓      | 01131-43202              |
| Ground collar assembly for single-ended browser                   | 2            |           |        | ✓      | 01130-60005              |
| Socketed ground lead 6 inches                                     | 1            |           |        | ✓      | E2676-21301              |

*a Not orderable.*

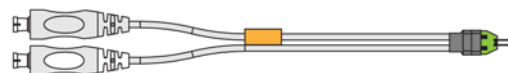
## Optional E2669A Differential Connectivity Kit and Accessories

The E2669A differential connectivity kit provides multiple quantities of the three probe heads as shown in Figure 5. These probe heads allow full bandwidth probing of differential and single-ended signals. The kit can be ordered at the same time as 1130/1/2/4A probe amplifiers.

E2678A Differential Socketed  
(quantity 2)



E2677A Differential Solder-In  
(quantity 4)



E2675A Differential Browser  
(quantity 1)

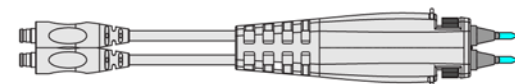


Figure 5 E2669A Differential Connectivity Kit (*not to scale*)

Table 8 Supplied Accessories (Sheet 1 of 2)

| Description   | Qty Supplied | Used With |        |        | Part Number <sup>a</sup> |
|---|--------------|-----------|--------|--------|--------------------------|
|   |              | E2678A    | E2677A | E2675A |                          |
| E2678A Differential Socketed Head                                 | 2            |           | —      |        | —                        |
| E2677A Differential Solder-In Head                                | 4            |           | —      |        | —                        |
| E2675A Differential Browser                                       | 1            |           | —      |        | —                        |
| 160Ω damped wire accessory  | 12           | ✓         |        |        | 01130-21302              |
| 82Ω resistor for full bandwidth                                   | 96           | ✓         |        |        | 01130-81506              |
| Socket for 25 mil (25/1000 inch) square pins, female on both ends | 8            | ✓         |        |        | 01131-85201              |

## 1 Getting Started

### Optional E2669A Differential Connectivity Kit and Accessories

**Table 8 Supplied Accessories (Sheet 2 of 2)**

| Description   | Qty Supplied | Used With |        |        | Part Number <sup>a</sup> |
|---|--------------|-----------|--------|--------|--------------------------|
|   |              | E2678A    | E2677A | E2675A |                          |
| 25 mil female socket w/20 mil round male pin on other end | 8            | ✓         |        |        | 01131-85202              |
| Heat shrink socket accessory                              | 8            | ✓         |        |        | 01130-41101              |
| Header adapter, 91Ω                                       | 4            | ✓         |        |        | 01130-63201              |
| 82Ω resistor template                                     | 1            | ✓         |        |        | 01131-94309              |
| 91Ω resistor for full bandwidth                           | 80           |           | ✓      |        | 0700-2353                |
| 150Ω resistor for medium bandwidth                        | 40           |           | ✓      |        | 0700-2350                |
| 91Ω resistor template                                     | 1            |           | ✓      |        | 01131-94311              |
| 150Ω resistor template                                    | 1            |           | ✓      |        | 01131-94308              |
| Resistive tip (blue), 91Ω                                 | 20           |           |        | ✓      | 01131-62102              |
| Ergonomic handle  | 1            |           |        | ✓      | 01131-43201              |

*a Not orderable.*

#### NOTE

Resistor performance. The S2 resistors were changed from 100 Ω to 91 Ω for slightly better performance. Either value produces a response that is well within specifications. If you have some of the older 100 Ω resistors, ensure that you use either two 100 Ω or two 91 Ω resistors. Do not mix them.

## Using the Velcro Dots

The velcro dots can be used to secure the probe amplifier to a circuit board removing the weight of the probe from the circuit connection. Attach a Velcro dots to both the probe amplifier and the circuit board as shown in [Figure 6](#) on page 21.

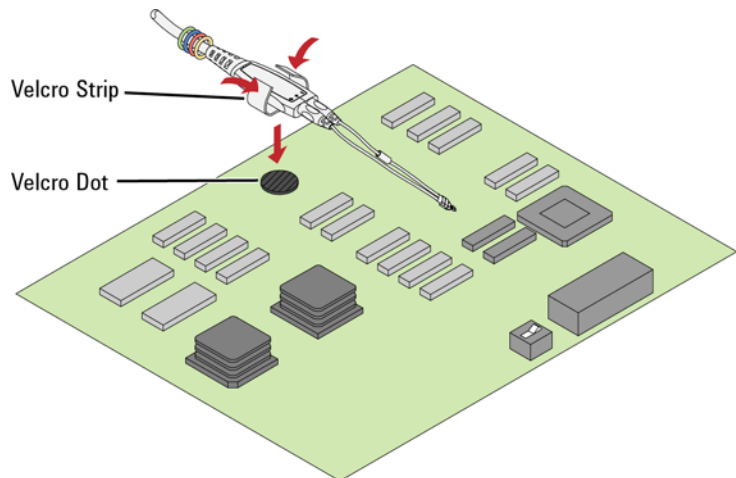


Figure 6 Using the Velcro Dots

---

## Other Available Accessories

This section contains information on the following accessories:

N5450B Extreme Temp Cable Extension Kit 22

N2880A InfiniiMax In-Line Attenuator Kit 24

N2881A InfiniiMax DC Blocking Caps 28

### **N5450B Extreme Temp Cable Extension Kit**

The extreme temperature cable extension kit is an accessory that allows an oscilloscope probe to be used to monitor a device in a temperature chamber. Agilent's Infiniimax probe amplifiers have a specified operating temperature range from 5° C to 40° C, but the probe heads can be operated over a much larger range of temperatures.

Use the extension cables to physically separate the amplifier from the probe head which allows you to operate the probe head inside a temperature chamber while the probe amplifier remains outside the chamber.

To ensure a high-quality measurement, the N5450B cable set have been phase-matched at the factory. A coupling tag is included with the cables to ensure the cables stay as a matched pair. To install the coupling tag, slip the small end of each cable through the holes in the tag. The tag can be positioned anywhere along the length of the cable and can withstand the temperature ranges specified.



**Table 9 Probing Temperature Ranges**

| Probe Head Configuration <sup>a</sup> | Temperature Range (°C) | Average Lifetime of the Probe Head (cycles) <sup>b</sup> |
|---------------------------------------|------------------------|--|
| N5381A                                | -55 to +150            | > 250  |
| E2677A                                | -25 to +80             | > 1000   |
| E2678A                                |                        |  |
| N5425A + N5426A                       |                        |  |
| N5451A                                |                        |  |

- a Refers to the probe head or tip that is attached to the cable extension kit.
- b A cycle is defined to be a temperature sweep from either -55° C to 150° C and then back to -55° C or from -25° C to 80° C and then back to -25° C depending upon the probe head configuration being used.

**CAUTION**

Avoid rapid changes in temperature that can lead to moisture accumulating in the form of condensation on the probe components, as well as the DUT. If this occurs, wait until the moisture has evaporated before making any measurements.

**CAUTION**

Additional care must be taken when handling probe heads used during extreme temperature cycling because this process makes the probe heads less robust.

**CAUTION**

Secure the ends of the extension cable near the probe head in the temperature chamber such that the probe head legs are not tugged or moved around significantly.

**CAUTION**

Prevent abrasion and tears in the cable's jacket, do not rest the extension cables on any metal objects or objects with sharp edges.

**CAUTION**

Do not kink the cables. The cables are designed to be flexible, but are not designed to be bent sharply.

## 1 Getting Started

### Other Available Accessories

---

**NOTE**

Keep your extreme temperature testing probes separate from the probes they use under milder conditions. This is because cycling probe heads through extreme temperature ranges has a marked affect on their lifetimes as listed in [Table 9](#). Only the lifetime of the probe head is affected by temperature cycling. The extension cables and probe amplifier should not need to be replaced with extended temperature cycling.

---

**NOTE**

Discoloration or texture changes are possible with the extension cables. These changes do not, however, affect the performance or the quality of a measurement.

---

### N2880A InfiniiMax In-Line Attenuator Kit

The in-line attenuators are an accessory for the probes. The dynamic ranges of the 1130A-series probes are 5 Vp-p. If you need to measure larger signals, the architecture of the InfiniiMax probes allows you to add the N2880A InfiniiMax In-Line Attenuators between the probe head and the probe amplifier to increase the dynamic range (see picture below). Additionally, these attenuators enable you to increase the offset range of the probe (see the table below). When using the N2880A In-Line Attenuators, the bandwidth and rise time of your probing system is not affected. There is, however, a trade-off in noise (see table below) and in the accuracy of DC offset relative to the input.



**Figure 7** Placement of Attenuators Between Probe Amplifier and Head



The maximum input voltage of the InfiniiMax probe heads is  $\pm 30$  Vdc (depending on the frequencies of your signal, the maximum allowed slew rate (see table below) may require that the maximum input voltage magnitude be less than 30V), so they should not be used to measure signals that exceed this range. This places a practical limit of 20 dB on the attenuators used with the InfiniiMax probing system. Larger attenuation ratios will only degrade the noise performance and gain of the system.

The N2880A kit consists of 3 pairs of attenuators (6 dB, 12 dB, and 20 dB). These attenuators come as matched pairs and should only be used with each other. If you look on each attenuator, you will see a serial number. The pair of matching attenuators in each set will have the same four digit numeric prefix and will differ by the last letter (one attenuator in the matched pair will be labeled A and the other will be labeled B).

All InfiniiMax probe heads and amplifiers are compatible with the N2880A In-Line Attenuators. However, due to the N5380B dual-SMA probe head's maximum input voltage specification of 2.28 V<sub>RMS</sub>, the N5380B is not suitable for measuring signals large enough to require an added attenuator.

**Table 10 N2880A With 1130A-Series Probe Amplifiers**

| Added Attenuator | Dynamic Range       | Offset Range            | Typical Noise Referred to | Maximum Allowed Input Slew Rate <sup>a</sup><br>(se = single-ended)<br>(diff = differential) | Nominal DC Attenuation of Probe System |
|------------------|---------------------|-------------------------|---------------------------|--|--|
| None             | 5 V <sub>p-p</sub>  | $\pm 12$ V              | 3 mV RMS                  | se: 18 V/ns, diff: 30 V/ns   | 10:1                                   |
| 6 dB (2:1)       | 10 V <sub>p-p</sub> | $\pm 24$ V              | 7.8 mV RMS                | se: 36 V/ns, diff: 60 V/ns   | 20:1                                   |
| 12 dB (4:1)      | 20 V <sub>p-p</sub> | $\pm 30$ V <sup>b</sup> | 16.7 mV RMS               | se: 72 V/ns, diff: 120 V/ns  | 40:1                                   |
| 20 dB (10:1)     | 50 V <sub>p-p</sub> | $\pm 30$ V*             | 41.7 mV RMS               | se: 180 V/ns, diff: 300 V/ns   | 100:1                                  |

<sup>a</sup> These slew rate do not apply when the N5380B SMA probe head is used with the InfiniiMax amplifiers.

## 1 Getting Started

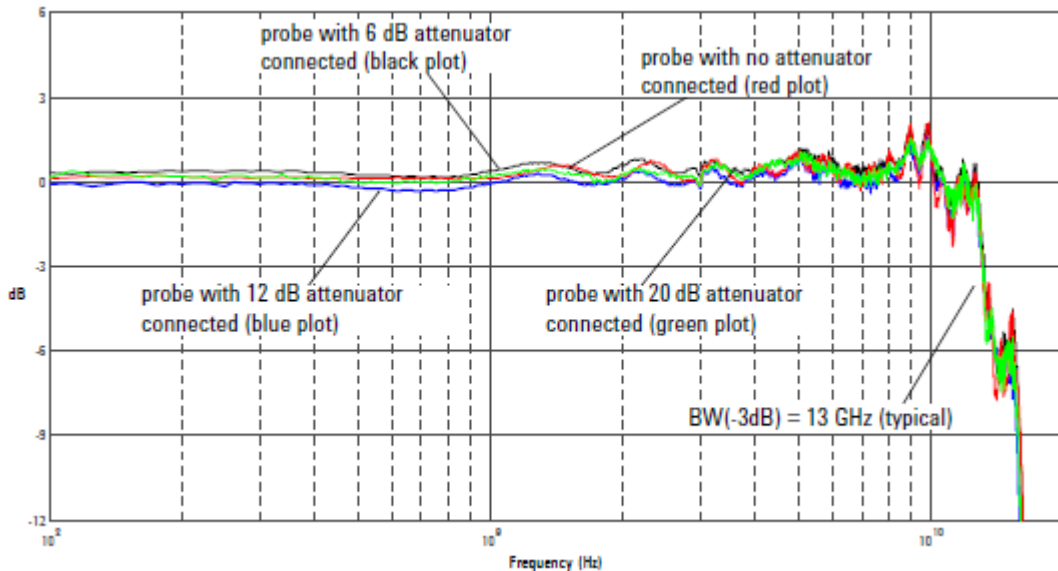
### Other Available Accessories

- b The actual range of DC voltage for these attenuators is greater than +/- 30 V, but the usable range of DC voltage at the probe input is limited to  $\pm 30$  Vdc. Also, depending on the frequencies of your signal, the maximum allowed slew rate may require that the maximum input voltage magnitude be less than 30 V.

**NOTE** The values shown above do not apply to the N5380B dual-SMA probe head. Due to the maximum input voltage specification of 2.28 VRMS for the N5380B, it is not suitable for measuring signals large enough to require an added attenuator.

### Frequency Response Plots

Below are the frequency response plots for four setups: the probe without any attenuators, the probe with the 6 dB attenuators, the probe with the 12 dB attenuators, and the probe with the 20 dB attenuators.



Red =  $\text{dB}(V_{\text{out}}/V_{\text{in}}) + 10.8$  dB of probe

Black =  $\text{dB}(V_{\text{out}}/V_{\text{in}}) + 6$  dB attenuator + 10.8 dB

Blue =  $\text{dB}(V_{\text{out}}/V_{\text{in}}) + 12$  dB attenuator + 10.8 dB of probe

Green =  $\text{dB}(\text{Vout}/\text{Vin}) + 20 \text{ dB attenuator} + 10.8 \text{ dB of probe}$

### Figure 8 Frequency Response

The software in the Infiniium and InfiniiVision oscilloscopes will detect a probe when it is connected and by default will assume that no additional attenuators are installed. If you want to scale readings and settings on the oscilloscope so they are correct with the attenuators installed, refer to the procedures below for your specific oscilloscope series.

#### Calibrating Attenuators on a Infiniium Scope

You cannot calibrate your InfiniiMax probes with the attenuators attached. Calibrate the InfiniiMax probes as you normally would (with no attenuators), configure the attenuators as discussed in the next section, and begin probing.

#### Configuring Attenuators on a Infiniium Scope

First, plug your InfiniiMax probe amplifier / probe head into one of the oscilloscope channels with the attenuators connected. Then enter the Probe Setup dialog box (can be reached via Setup > Probes on the oscilloscope menu). Press the Configure Probing System button. A pop-up window will appear where you can select External Scaling. Click the Decibel radio button under the External Scaling section and then set the Gain field to either -6 dB, -12 dB, or -20 dB depending on the attenuator you are using (be sure to include the negative sign). Finally, you will need to manually set the Offset field in this dialog box to zero out the signal.

#### Calibrating Probe with Attenuators on a InfiniiVision Scope

The following instructions only apply if you have InfiniiVision software release 5.25 or newer installed on your oscilloscope.

- 1 Plug your InfiniiMax probe amplifier / probe head into one of the oscilloscope channels with the attenuators attached.
- 2 Press the Channel on/off key to turn the channel on (if the channel is off).

## 1 Getting Started

### Other Available Accessories

- 3 Press the Probe softkey in the Channel menu. A series of probe related softkeys will appear.
- 4 Repeatedly press the second softkey from the left softkey until the probe head selection matches the attenuator you are using. The choices are:
  - 10:1 single-ended browser
  - 10:1 differential browser
  - 10:1 (+6 dB Atten) single-ended browser
  - 10:1 (+6 dB Atten) differential browser
  - 10:1 (+12 dB Atten) single-ended browser
  - 10:1 (+12 dB Atten) differential browser
  - 10:1 (+20 dB Atten) single-ended browser
  - 10:1 (+20 dB Atten) differential browser

Once the probe head configuration has been selected, you can press the Calibration key in the same probe menu and follow the on-screen instructions to calibrate the probe/attenuator setup.

### N2881A InfiniiMax DC Blocking Caps

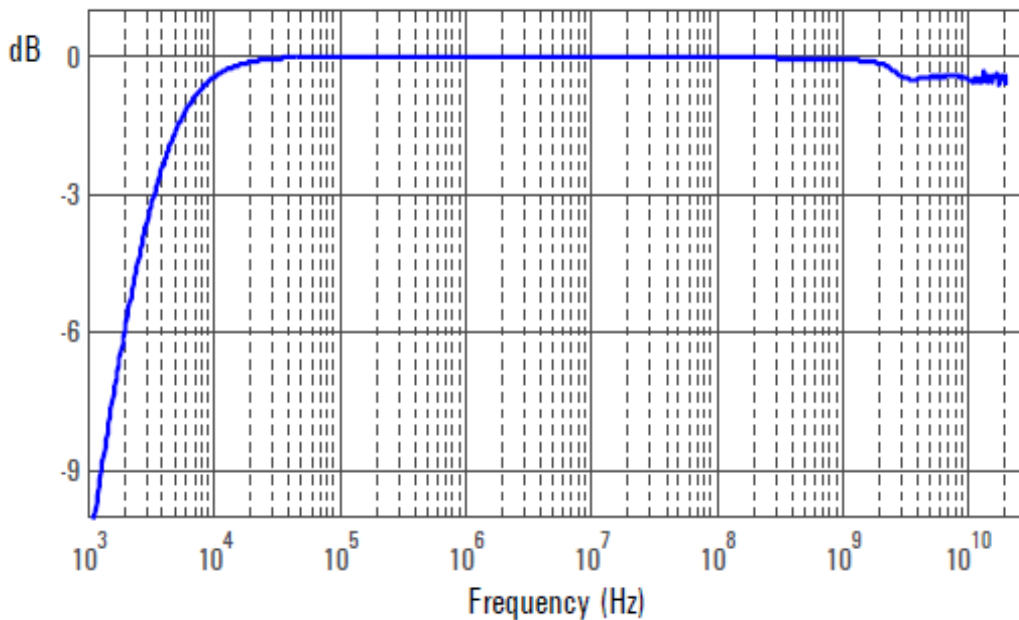
The DC blocking capacitors are an accessory for the probes. The architecture of the InfiniiMax probing system allows you to place the N2881A DC Blocking Caps in between the probe amplifier and the probe head (as shown in the picture below). These N2881A InfiniiMax DC Blocking Caps block out the DC component of the input signal (up to 30 Vdc).



**Figure 9** Placement of DC Blocking Caps Between Probe Amplifier and Head

The N2881A InfiniiMax DC Blocking Caps can be used with the N2880A In-Line Attenuators. The order of the two products in the probing system (i.e. which one is closest to the probe amplifier) does not matter.

Below is the frequency response plot of the N2881A DC Blocking Caps (no probe included).



**Figure 10** Graph of DC Blocking Cap insertion loss (S2,1) versus frequency (DC Blocking Cap only)

## Probe Handling

This probe has been designed to withstand a moderate amount of physical and electrical stress. However, with an active probe, the technologies necessary to achieve high performance do not allow the probe to be unbreakable. Treat the probe with care. It can be damaged if excessive force is applied to the probe tip. This damage is considered to be abuse and will void the warranty when verified by Agilent Technologies service professionals.

- Exercise care to prevent the probe end from receiving mechanical shock.
- Store the probe in a shock-resistant case such as the foam-lined shipping case which came with the probe.

### Connecting and Disconnecting Probe Heads

When disconnecting a probe head from an amplifier, pull the probe head connectors straight out of the sockets as shown in [Figure 11](#). When connecting a probe head to an amplifier, push straight in. Always grasp the indentations located on the sides of the amplifier as shown in [Figure 11](#). There are also indentations on many of the probe head sockets so you have a convenient place to grasp there as well.



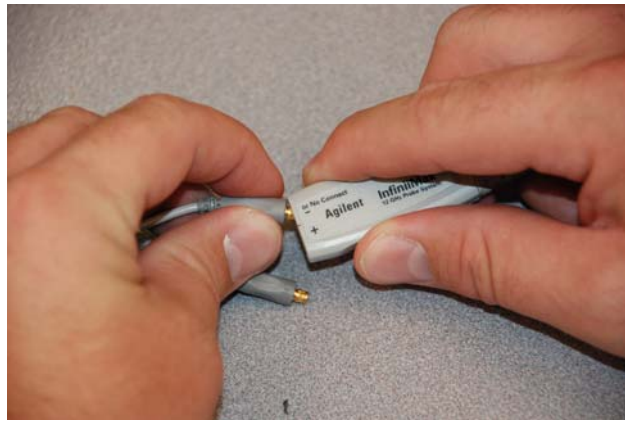
**Figure 11** Properly Pulling the Probe Head Straight Out

---

CAUTION

---

Avoid damaging the connection pins. Never bend the probe head in order to “pop” it loose from the amplifier. Do not wiggle the probe head up and down or twist it to remove the connectors from the sockets.



**Figure 12** Improperly Disconnecting a Probe Head From an Amplifier

### Handling the Probe Cable

---

CAUTION

---

Avoid degrading the probe’s performance. Do not twist, kink, or tightly bend the probe’s cable.

---

CAUTION

---

When the probe is attached to an oscilloscope, avoid letting object hit the probe cable where the cable exits the probe amplifier and bend it well beyond its limit.

When storing the probe, coil the cable in a large loops and avoid twisting the cable. Coil the cable in a similar manner to how garden hoses or extension cords are typically coiled. You can start by wrapping the cable around your thumb as shown in [Figure 13](#). Then continue to circle your thumb, but provide a slight twist with each rotation. This allows the cable rotations to lie flat against each other and will eliminate the net twisting of the cable in the end.



**Figure 13 Recommended Coil for Storage**

---

**CAUTION**

---

Make the coil's radius fairly large so it does not induce kinking or bending.

### **Connecting the Probe to an Oscilloscope**

The probes are only meant to be plugged into gold plated BNCs (like those on Infiniium oscilloscopes). To connect the probe to the oscilloscope, simply push the probe into the BNC connector and the locking mechanism automatically engages. To disconnect the probe, push and hold the locking lever to the left and then remove the probe.

### **Handling the Probe Amplifier**

The probe amplifier contains a delicate circuit board. Treat it carefully and take standard precautions (for example, not dropping it repeatedly or from large heights, not getting it wet, not smashing it with heavy objects, etc.). These probes are sensitive ESD devices so standard precautions need to be used to not ruin the probe from the build-up of static charges.

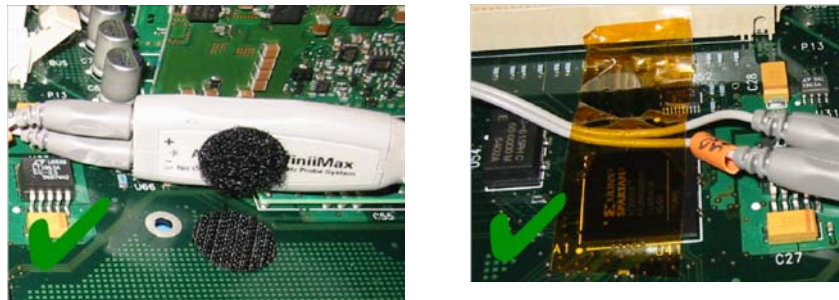
### **Securing Probe Heads and Amplifiers to Your DUTs**

When soldering a probe head to a circuit, first provide strain relief by using low temperature hot glue (use as little as possible) or non-conductive double-sided tape. Do not use



super glue and do not get the low temperature hot glue on the actual probe head tip as this can damage the precision components of your probing system (only use the low temperature hot glue on the probe head cables). The provided velcro pads can be used to secure your probe amplifier casing to the board.

Once strain relief has been provided, solder the probe tip to the circuit board and then plug the probe head into the probe amplifier.



**Figure 14 Correct Securing Methods**



**Figure 15 Incorrect Securing Method Because Glue is Placed on the Probe Head Tip**

## Using Offset With InfiniiMax Active Probes

It is important to understand how the 113xA probes behave with respect to offset when different probe head / signal combinations are used.

The purpose of offset in active probes or oscilloscope front ends is to allow the subtraction of most or all of the dc component of the input signal so the signal can better utilize the dynamic range of the input. When using an InfiniiMax probe with an Infiniium oscilloscope, you can select the case (see the three cases described below) that applies for your measurement by selecting the **Probes** button under the channel setup menu. This allows you to select which type of probe head is being used and, if it is a differential probe head, allows you to select whether you are probing a differential or single-ended signal. With these inputs, the oscilloscope will use the proper type of offset for your measurement case. The specifics for each case are discussed below.

As an important side note, whenever adjusting the offset for a particular probe head, make sure to have a triggered signal.

### **Case 1. A single-ended probe head probing a single-ended signal**

For this case, the offset control on the oscilloscope controls the probe offset and the channel offset is set to zero. This allows the offset voltage to be subtracted from the input signal before the signal gets to the differential amplifier. Since this subtraction is done before any active circuits, the offset range is large ( $\pm 12\text{V}$  for the 113X amplifiers and 25-k $\Omega$  probe heads). Note that the minus probe tip is not present when using a single-ended probe head which means nothing is plugged into the "-" input of the probe amp. This is normal and causes no problems.

**Case 2. A differential probe head probing a single-ended signal**

For this case, the offset control on the oscilloscope controls the probe offset and the channel offset is set to zero. This allows the offset voltage to be subtracted from the input signal before the signal gets to the differential amplifier. Since this subtraction is done before any active circuits, the offset range is large ( $\pm 12\text{V}$  for the 113X amplifiers and 25-k $\Omega$  probe heads). A differential probe can make higher bandwidth and more accurate measurements on single-ended signals than a single-ended probe and this method of applying offset to only the plus side of a differential probe means there is no sacrificing of offset range.

**Case 3. A differential probe head probing a differential signal**

For this case, the offset control on the oscilloscope controls the oscilloscope channel offset. The probe offset is not used and set to zero. Since the plus and minus sides of differential signals have the same dc component, it will be subtracted out and the output of the probe will by definition be centered around ground.

The channel offset allows the waveform seen on screen to be moved as desired. The allowable dc component in the plus and minus signals is determined by the common mode range of the probe which for the 113x probe amps and 25-k $\Omega$  probe heads is  $\pm 6.75\text{ V}$ .

## Slew Rate Requirements for Different Technologies

The following table shows the slew rates for several different technologies. The maximum allowed input slew rate is 18 V/ns for single-ended signals and 30 V/ns for differential signals. Table 11 shows that the maximum required slew rate for the different technologies is much less that of the probe.

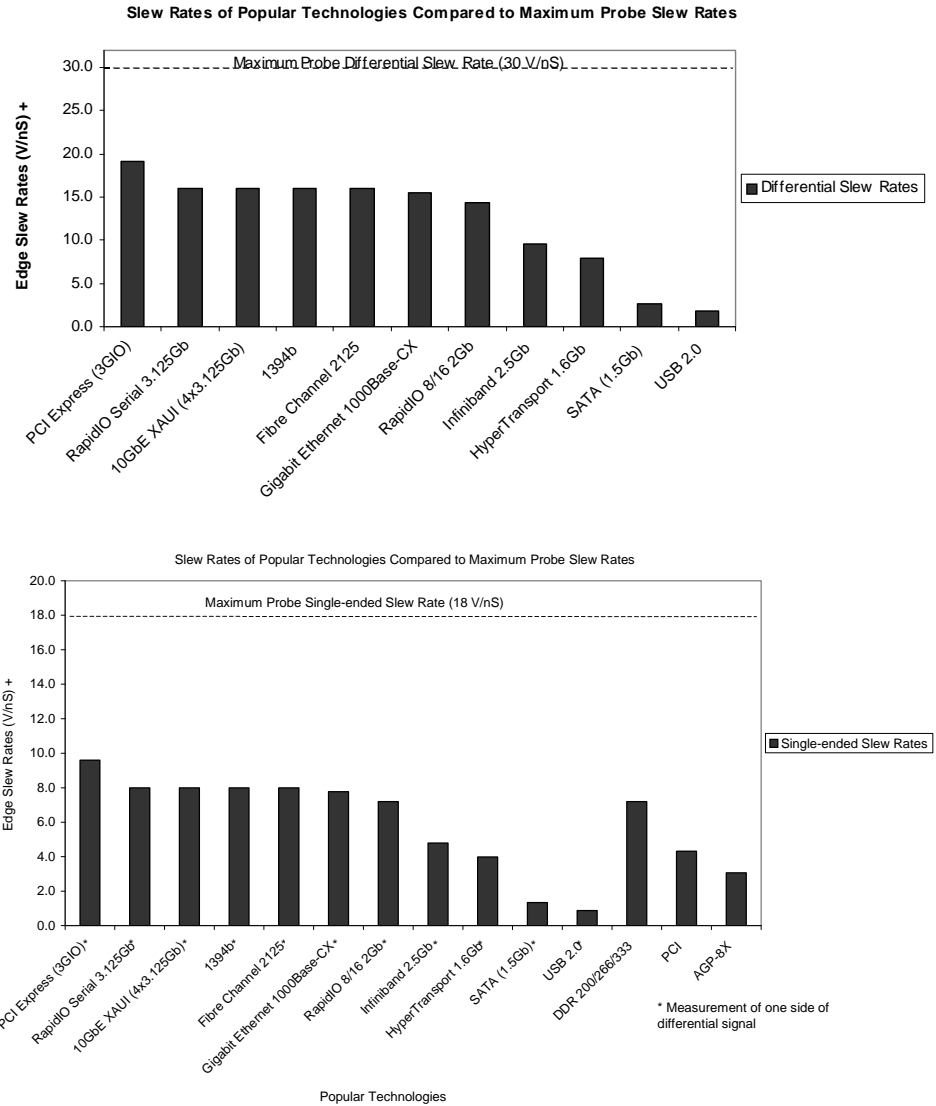
**Table 11 Slew Rate Requirements**

| Name of Technology           | Differential Signal | Max Single-Ended Slew Rate <sup>a</sup> (V/ns) | Max Differential Slew Rate <sup>b</sup> (V/ns) | Driver Min Edge Rate (20%-80% ps) | Max Transmitter Level (Diff V) |
|------------------------------|---------------------|--|--|-----------------------------------|--------------------------------|
| PCI Express (3GIO)           | YES                 | 9.6  | 19.2   | 50                                | 1.6                            |
| RapidIO Serial 3.125Gb       | YES                 | 8.0  | 16.0   | 60                                | 1.6                            |
| 10GbE XAUI (4x3.125Gb)       | YES                 | 8.0  | 16.0   | 60                                | 1.6                            |
| 1394b                        | YES                 | 8.0  | 16.0   | 60                                | 1.6                            |
| Fibre Channel 2125           | YES                 | 8.0  | 16.0   | 75                                | 1                              |
| Gigabit Ethernet 1000Base-CX | YES                 | 7.8  | 15.5   | 85                                | 2.2                            |
| RapidIO 8/16 2Gb             | YES                 | 7.2  | 14.4   | 50                                | 1.2                            |
| Infiniband 2.5Gb             | YES                 | 4.8  | 9.6  | 100                               | 1.6                            |
| HyperTransport 1.6Gb         | YES                 | 4.0  | 8.0  | 113                               | 1.5                            |
| SATA (1.5Gb)                 | YES                 | 1.3  | 2.7  | 134                               | 0.6                            |
| USB 2.0                      | YES                 | 0.9  | 1.8  | 375                               | 1.1                            |
| DDR 200/266/333              | NO                  | 7.2  | n/a  | 300                               | 3.6                            |
| PCI                          | NO                  | 4.3  | n/a  | 500                               | 3.6                            |
| AGP-8X                       | NO                  | 3.1  | n/a  | 137                               | 0.7                            |

a The probe specification is 18 V/ns

b The probe specification is 30 V/ns

Slew Rate Requirements for Different Technologies



**Figure 16 Slew Rates of Popular Technologies Compared to Maximum Probe Slew Rates**

**1 Getting Started**  
Slew Rate Requirements for Different Technologies

$$\frac{\text{Maximum Edge Amplitude} \times 0.6}{\text{Minimum 20\% to 80\% Rise Time}}$$

---

## Safety Information



This manual provides information and warnings essential for operating this probe in a safe manner and for maintaining it in safe operating condition. Before using this equipment and to ensure safe operation and to obtain maximum performance from the probe, carefully read and observe the following warnings, cautions, and notes.

This product has been designed and tested in accordance with accepted industry standards, and has been supplied in a safe condition. The documentation contains information and warnings that must be followed by the user to ensure safe operation and to maintain the product in a safe condition.

Note the external markings on the probe that are described in this document.

To avoid personal injury and to prevent fire or damage to this product or products connected to it, review and comply with the following safety precautions. Be aware that if you use this probe assembly in a manner not specified, the protection this product provides may be impaired.

---

**WARNING**

**Use Only Grounded Instruments.**

**Do not connect the probe's ground lead to a potential other than earth ground. Always make sure the probe and the oscilloscope are grounded properly.**

---

**WARNING**

**Connect and Disconnect Properly.**

**Connect the probe to the oscilloscope and connect the ground lead to earth ground before connecting the probe to the circuit under test. Disconnect the probe input and the probe ground lead from the circuit under test before disconnecting the probe from the oscilloscope.**

---

## 1 Getting Started

### Safety Information

---

**WARNING**

---

**Observe Probe Ratings.**  
Do not apply any electrical potential to the probe input which exceeds the maximum rating of the probe. Make sure to comply with the voltage versus frequency derating curve found in this manual.

---

**WARNING**

---

**Indoor Use Only.**  
Do not operate in wet/damp environments. Keep product surfaces dry and clean.

---

**WARNING**

---

**Do Not Operate With Suspected Failures.** Refer to qualified service personnel.

---

**WARNING**

---

**Never leave the probe connected to a conductor while it is not connected to an oscilloscope or voltage measuring instrument.**

---

**WARNING**

---

**Do not use a probe which is cracked, damaged or has defective leads.**

---

**WARNING**

---

**Do not install substitute parts or perform any unauthorized modification to the probe.**

---

**WARNING**

---

**Do not operate the probe or oscilloscope in the presence of flammable gasses or fumes. Operation of any electrical instrument in such an environment constitutes a definite safety hazard.**

---

**WARNING**

---

**Do not use the probe or oscilloscope in a manner not specified by the manufacturer.**

---

**WARNING**

---

**Service instructions are for trained service personnel. To avoid dangerous electric shock, do not perform any service unless qualified to do so. Do not attempt internal service or adjustment unless another person, capable of rendering first aid and resuscitation, is present.**

---

**CAUTION**

---

The probe cable is a sensitive part of the probe and, therefore, you should be careful not to damage it through excessive bending or pulling. Avoid any mechanical shocks to this product in order to guarantee accurate performance and protection.

---



### Concerning the Oscilloscope or Voltage Measuring Instrument to Which the Probe is Connected

---

**WARNING**

Whenever it is likely that the ground protection is impaired, you must make the instrument inoperative and secure it against any unintended operation.

---

**WARNING**

If you energize the instrument by an auto transformer (for voltage reduction or mains isolation), the ground pin of the input connector terminal must be connected to the earth terminal of the power source.

---

**WARNING**

Before turning on the instrument, you must connect the protective earth terminal of the instrument to the protective conductor of the (mains) power cord. The mains plug shall only be inserted in a socket outlet provided with a protective earth contact. You must not negate the protective action by using an extension cord (power cable) without a protective conductor (grounding). Grounding one conductor of a two-conductor outlet is not sufficient protection.

---

**WARNING**

Only fuses with the required rated current, voltage, and specified type (normal blow, time delay, etc.) should be used. Do not use repaired fuses or short-circuited fuse holders. To do so could cause a shock or fire hazard.

---

**WARNING**

Capacitors inside the instrument may retain a charge even if the instrument is disconnected from its source of supply.

---

---

## Service

The following symptoms may indicate a problem with the probe or the way it is used. The probe is a high frequency device with many critical relationships between parts. For example, the frequency response of the amplifier on the hybrid is trimmed to match the output coaxial cable. As a result, to return the probe to optimum performance requires factory repair. If the probe is under warranty, normal warranty services apply.

### Probe Calibration Fails

Probe calibration failure with an oscilloscope is usually caused by improper setup. If the calibration will not pass, check the following:

- Check that the probe passes a waveform with the correct amplitude.
- If the probe is powered by the oscilloscope, check that the offset is approximately correct. The probe calibration cannot correct major failures.
- Be sure the oscilloscope passes calibration without the probe.

### Incorrect Pulse Response (flatness)

If the probe's pulse response shows a top that is not flat, check for the following:

- Output of probe must be terminated into a proper 50  $\Omega$  termination. If you are using the probe with an Infiniium oscilloscope, this should not be a problem. If you are using the probe with other test gear, ensure the probe is terminated into a low reflectivity 50 $\Omega$  load ( $\sim \pm 2\%$ ).
- If the coax or coaxes of the probe head in use has excessive damage, then reflections may be seen within  $\sim 1$  ns of the input edge. If you suspect a probe head, swap it with another probe head and see if the non-flatness problem is fixed.

- If the one of the components in the tip have been damaged there may be a frequency gain non-flatness at around 40 MHz. If you suspect a probe head, swap it with another probe head and see if the non-flatness problem is fixed.

### Incorrect Input Resistance

The input resistance is determined by the probe head in use. If the probe head is defective, damaged, or has been exposed to excessive voltage, the input resistor may be damaged. If this is the case, the probe head is no longer useful. A new probe head will need to be obtained either through purchase or warranty return.

### Incorrect Offset

Assuming the probe head in use is properly functioning, incorrect offset may be caused by defect or damage to the probe amplifier or by lack of probe calibration with the oscilloscope.

### Returning the Probe for Service

If the probe is found to be defective we recommend sending it to an authorized service center for all repair and calibration needs. Perform the following steps before shipping the probe back to Agilent Technologies for service.

- 1 Contact your nearest Agilent sales office for information on obtaining an RMA number and return address.
- 2 Write the following information on a tag and attach it to the malfunctioning equipment.
  - Name and address of owner
  - Product model number (for example, N2820A)
  - Product Serial Number (for example, MYXXXXXXXX)
  - Description of failure or service required

---

**NOTE**

---

Include probing and browsing heads if you feel the probe is not meeting performance specifications or a yearly calibration is requested.

- 3 Protect the probe by wrapping in plastic or heavy paper.

## 1 Getting Started Service

- 4 Pack the probe in the original carrying case or if not available use bubble wrap or packing peanuts.
- 5 Place securely in sealed shipping container and mark container as "FRAGILE".

---

### NOTE

---

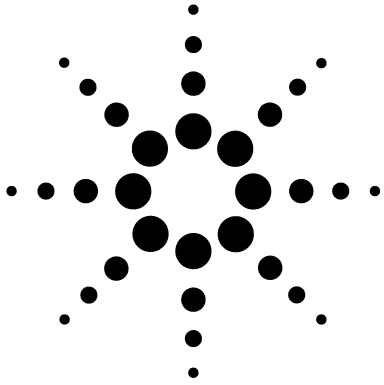
If any correspondence is required, refer to the product by serial number and model number.

### Contacting Agilent Technologies

For technical assistance, contact your local Agilent Call Center.

■ In the Americas, call 1 (800) 829-4444

■ In other regions, visit <http://www.agilent.com/find/assist>  
Before returning an instrument for service, you must first call the Call Center at 1 (800) 829-4444.



## 2 Using Probe Heads

|  |    |
|--|----|
| Recommended Configurations at a Glance                       | 46 |
| E2677A Differential Solder-in Head with Full BW Resistors    | 48 |
| E2678A Differential Socketed Head                            | 50 |
| E2675A Differential Browser                                  | 53 |
| N5380B SMA Head  | 56 |
| E2679A Single-Ended Solder-In Head                           | 59 |
| E2676A Single-Ended Browser                                  | 61 |
| E2677A Differential Solder-In Head with Medium BW Resistors  | 63 |
| E2679A Single-Ended Solder-In Head with Long Wire            | 65 |
| E2678A Differential Socketed Head with Damped Wire Accessory | 67 |
| E2678A Differential Socketed Head with Header Adapter        | 69 |
| Replacing Resistors on E2677A/9A Solder-In Probe Heads       | 71 |

### Performance Graphs

Graphs showing the performance of the heads for each probe amplifier are shown in [Chapter 5](#), [Chapter 6](#), [Chapter 7](#), and [Chapter 8](#).

This chapter describes the various probe heads. The probe configurations are listed in the order of the best performance to the least performance. The recommended configurations are designed to give the best probe performance for different probing situations. This allows you to quickly make the measurements you need with confidence in the performance and signal fidelity. Using the recommended connection configurations is your key to making accurate oscilloscope measurements with known performance levels.

## Recommended Configurations at a Glance

Table 12 Configurations at a Glance (Sheet 1 of 2)

| Recommended Order of Use  | BW (GHz)  | Cdiff <sup>a</sup> (pF) | Cse <sup>b</sup> (pF) | Usage  |
|---|---|-------------------------|-----------------------|--|
| <b>E2677A Differential Solder-In (full bandwidth resistors) (Refer to page 48.)</b> |   |                         |                       |  |
| 1   | 1130A: >1.5<br>1131A: >3.5<br>1132A: >5<br>1134A: > 7   | 0.27                    | 0.44                  | Differential and Single-ended signals<br>Solder-in hands free connection<br>Hard to reach targets<br>Very small fine pitch targets<br>Characterization   |
| <b>E2678A Differential Socketed (full bandwidth resistors) (Refer to page 50.)</b>  |   |                         |                       |  |
| 2   | 1130A: >1.5<br>1131A: ~3.5<br>1132A: >5<br>1134A: > 7   | 0.34                    | 0.56                  | Differential and Single-ended signals<br>Removable connection using solder-in resistor pins<br>Hard to reach targets   |
| <b>E2675A Differential Browser (Refer to page 53.)</b>                              |   |                         |                       |  |
| 3   | 1130A: >1.5<br>1131A: ~3.5<br>1132A: >5<br>1134A: ~ 6   | 0.32                    | 0.57                  | Differential and Single-ended signals<br>Hand-held browsing<br>Probe holders<br>General purpose troubleshooting<br>Ergonomic handle available  |
| <b>N5380B Differential SMA Head (Refer to page 56.)</b>                             |   |                         |                       |  |
| 4   | 1130A: >1.5<br>1131A: >3.5<br>1132A: >5<br>1134A: >6    | N/A                     | N/A                   | Full bandwidth<br>Preserve oscilloscope channels as opposed to using the A minus B mode.<br>Removes inherent cable loss through compensation.<br>Common mode termination voltage can be applied<br>Offset matched sma cables adapt to variable spacing |
| <b>E2679A Single-Ended Solder-In (full bandwidth resistors) (Refer to page 59.)</b> |   |                         |                       |  |
| 5   | 1130A: >1.5<br>1131A: ~3.5<br>1132A: >5<br>1134A: ~ 5.2 | N/A                     | 0.50                  | Single-ended signals only<br>Solder-in hands free connection when physical size is critical<br>Hard to reach targets<br>Very small fine pitch targets  |

**Table 12 Configurations at a Glance (Sheet 2 of 2)**

| Recommended Order of Use  | BW (GHz)  | Cdiff <sup>a</sup> (pF) | Cse <sup>b</sup> (pF) | Usage  |
|---|---|-------------------------|-----------------------|--|
| <b>E2676A Single-Ended Browser (Refer to page 61.)</b>                                |   |                         |                       |  |
| <b>6</b>  | 1130A: >1.5<br>1131A: ~3.5<br>1132A: >5<br>1134A: ~ 5.5     | N/A                     | 0.65                  | Single-ended signals only<br>Hand or probe holder where physical size is critical<br>General purpose troubleshooting<br>Ergonomic handle available                                     |
| <b>E2677A Differential Solder-In (medium bandwidth resistors) (Refer to page 63.)</b> |   |                         |                       |  |
| <b>7</b>  | 1130A: >1.5<br>1131A: ~2.9<br>1132A: ~2.9<br>1134A: ~ 2.9   | 0.33                    | 0.52                  | Differential and Single-ended signals<br>Solder-in hands free connection<br>Larger span and reach than #1<br>Very small fine pitch targets   |
| <b>E2679A Single-Ended Solder-In with Long Wire (Refer to page 65.)</b>               |   |                         |                       |  |
| <b>8</b>  | 1130A: >1.5<br>1131A: ~2.2<br>1132A: ~ 2.2<br>1134A: ~ 2.2  | N/A                     | 0.58                  | Single-ended signals only<br>Solder-in hands free connection when physical size is critical<br>Larger span and reach than #4<br>Hard to reach targets<br>Very small fine pitch targets |
| <b>E2678A Differential Socketed with Damped Wire Accessory (Refer to page 67.)</b>    |   |                         |                       |  |
| <b>9</b>  | 1130A: ~ 1.2<br>1131A: ~1.2<br>1132A: ~ 1.2<br>1134A: ~ 1.2 | 0.63                    | 0.95                  | Differential and Single-ended signals<br>For very wide spaced targets<br>Connection to 25 mil square pins when used with supplied sockets  |
| <b>E2678A Differential Socketed with Header Adapter (Refer to page 69.)</b>           |   |                         |                       |  |
| <b>10</b>   | 1130A: ~ 1.2<br>1131A: ~1.2<br>1132A: ~ 1.2<br>1134A: ~ 1.2 | 0.70                    | 0.97                  | Differential and Single-ended signals<br>For very wide spaced targets<br>Connection to 25 mil square pins when used with supplied sockets  |

- a Capacitance seen by differential signals
- b Capacitance seen by single-ended signals

## 1 E2677A Differential Solder-in Head with Full BW Resistors

Full BW



This probe configuration provides the full bandwidth signals and the lowest capacitive loading for measuring both single-ended and differential signals. This head allows a soldered connection into a system for a reliable, hands-free connection. At the tip it uses a miniature axial lead resistor with 8 mil diameter leads which allows connection to very small, fine pitch targets.

Table 13 Bandwidth

| Probe Amplifier | BW (GHz) | Probe Amplifier | BW (GHz) |
|-----------------|----------|-----------------|----------|
| 1130A           | >1.5     | 1132A           | >5       |
| 1131A           | >3.5     | 1134A           | >7       |

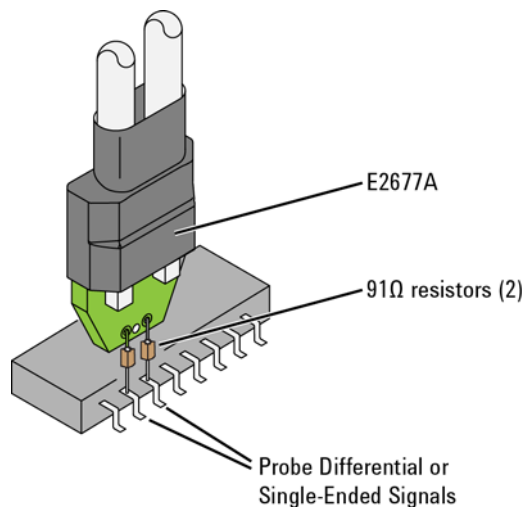


Figure 17 E2677A



The probe head resistors must be soldered to the circuit that you are measuring. Because of the small size of the resistor leads, it is easy to solder them to very small geometry circuits.



**TO INSTALL OR REPAIR RESISTOR LEADS.** Refer to “Replacing Resistors on E2677A/9A Solder-In Probe Heads” on page 71.



**PERFORMANCE PLOTS.** Refer to Chapter 5, “1130A Performance Data Plots”, Chapter 6, “1131A Performance Data Plots”, Chapter 7, “1132A Performance Data Plots”, and Chapter 8, “1134A Performance Data Plots”.

---

**CAUTION**

Do not solder in resistor leads with a big ball of solder right next to the resistor body. Normally the nickel lead will limit the heat transfer to the resistor body and protect the resistor, but if a ball of solder is right next to the resistor body on the lead, the resistor may come apart internally.

---

**CAUTION**

When soldering leads to DUT always use plenty of flux. The flux will ensure a good, strong solder joint without having to use an excessive amount of solder.

---

**CAUTION**

Strain relieve the micro coax leading away from the solder-in tips using hook-and-loop fasteners or adhesive tape to protect delicate connections.

---

**NOTE**

Before using the resistors, the resistor wires must be cut to the correct dimensions. For the correct dimensions see “Replacing Resistors on E2677A/9A Solder-In Probe Heads” on page 71

## 2 E2678A Differential Socketed Head

Full BW

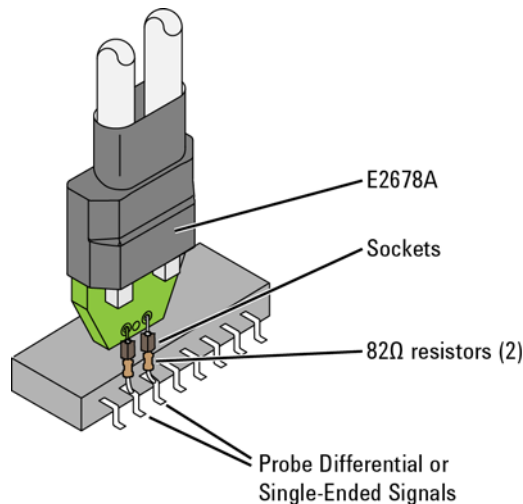


This probe configuration allows a removable, hands-free connection that provides full bandwidth with a minor increase in capacitance over the probe head for probing differential and single-ended signals.

Additionally, 3.6 cm resistor tip wire accessories are provided for high fidelity lower bandwidth probing of signals with very wide spacing. It is recommended that a 25 mil diameter plated through hole on the board for mounting the lead resistors.

**Table 14 Bandwidth**

| Probe Amplifier | BW (GHz) | Probe Amplifier | BW (GHz) |
|-----------------|----------|-----------------|----------|
| 1130A           | >1.5     | 1132A           | >5       |
| 1131A           | ~3.5     | 1134A           | >7       |



**Figure 18 E2678A**

The 82Ω axial lead resistors are soldered to the circuit that you are measuring. The socketed differential probe head is plugged onto the resistors. This makes it easier to move the probe from one location to another. Because of the larger size of the resistor leads, the target for soldering must be larger than the solder-in probe heads.



**TO INSTALL OR REPAIR RESISTOR LEADS.** Refer to the information found in this section.



**PERFORMANCE PLOTS.** Refer to [Chapter 5](#), “1130A Performance Data Plots”, [Chapter 6](#), “1131A Performance Data Plots”, [Chapter 7](#), “1132A Performance Data Plots”, and [Chapter 8](#), “1134A Performance Data Plots”.

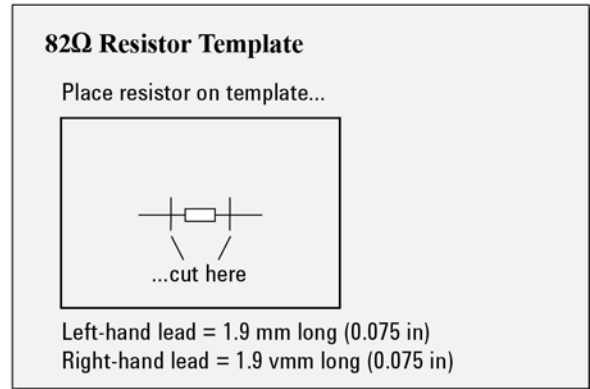
## PC Board Target Dimensions

The spacing for the socketed tip differential probe head is 0.100 inch (2.54 mm). For soldering on a PC board, the targets can be two vias that can accept the 0.020 inch (0.508 mm) diameter resistor leads. A via of 0.025 inch (0.0635 mm) diameter is recommended. If soldering a resistor lead to a surface pad on your PC board, the resistor leads can be bent in an "L" shape and soldered down. A pad size of at least 0.030 x 0.030 inch (0.762 mm x 0.762 mm) is recommended.

## Shaping the Resistors

Before installing the 82Ω resistors (01130-81506) onto your device under test, the resistor wires must be trimmed using diagonal cutters and bent to the correct dimensions as shown in [Figure 19](#). Use tweezers, to place the resistor body inside the rectangle of the supplied trim guage. Use diagonal cutters to trim the leads even with the trim lines.

**2 Using Probe Heads**  
Recommended Configurations at a Glance



**Figure 19 Resistor Trim Dimensions and Trim Gauge**

### 3 E2675A Differential Browser

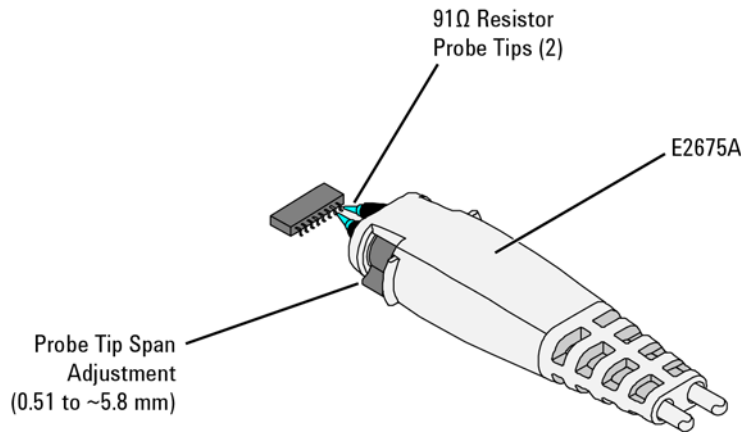
**General Purpose**



The E2675A differential browser configuration is the best choice for general purpose troubleshooting of a circuit board. This probe head provides the highest performance hand-held browser for measuring differential and single-ended signals while maintaining excellent usability due to the adjustable tip spacing and full z-axis compliance. The tab on the side of the probe allows the probe tips to be adjusted for different circuit geometries.

**Table 15 Bandwidth**

| Probe Amplifier | BW (GHz) | Probe Amplifier | BW (GHz) |
|-----------------|----------|-----------------|----------|
| 1130A           | >1.5     | 1132A           | >5       |
| 1131A           | ~3.5     | 1134A           | >6       |



**Figure 20 Differential Browser**

## 2 Using Probe Heads

### Recommended Configurations at a Glance



**PERFORMANCE PLOTS.** Refer to [Chapter 5](#), “1130A Performance Data Plots”, [Chapter 6](#), “1131A Performance Data Plots”, [Chapter 7](#), “1132A Performance Data Plots”, and [Chapter 8](#), “1134A Performance Data Plots”.

---

#### CAUTION

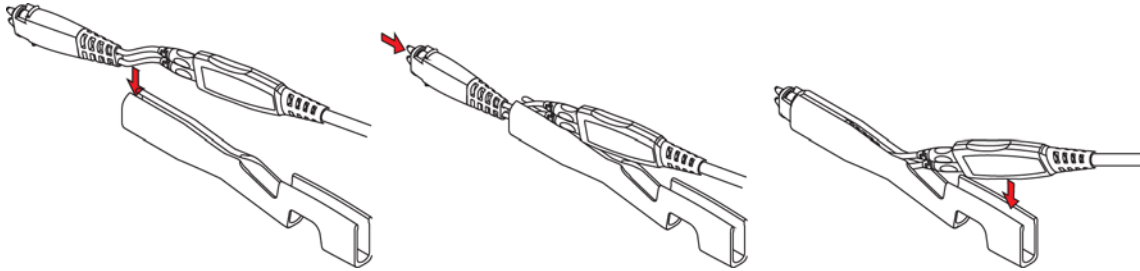
Do not use the E2675A probe head as a tool to scrape solder mask or other items off of a circuit board. The blue tips can easily be broken off if the browser is not used properly. Always hold the probe head so that the blue tips remain vertical during measurements as shown in [Figure 21](#).

---

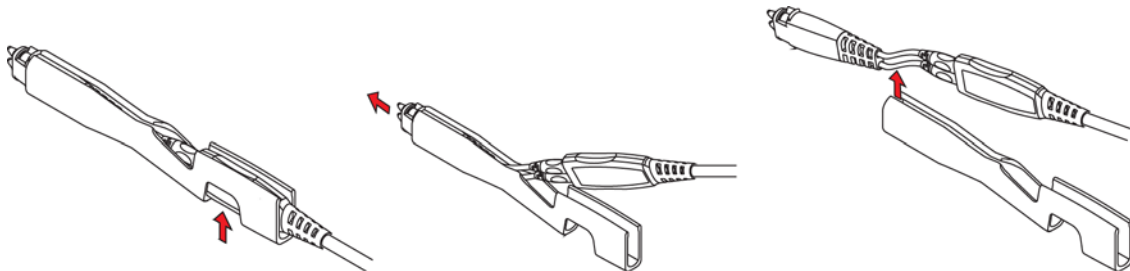


**Figure 21** Proper Vertical Orientation of the Blue Tips

When holding the E2675A for extended periods of time, use the supplied ergonomic handle. **Figure 22** and **Figure 23** show how to attach and remove the handle from the probe head.



**Figure 22** Inserting the Probe



**Figure 23** Removing the Probe

## 4 N5380B SMA Head

Full BW



The N5380B SMA probe head provides the highest bandwidth for connecting to SMA connectors. The input resistance is 50Ω on both inputs. A shorting cap connects one side of both resistances to ground. For applications that require the resistances to be referenced to a voltage other than ground, the shorting cap can be removed and a dc voltage can be applied.

### NOTE

The E2695A 8 GHz SMA head for InfiniiMax I probe amplifiers was discontinued in December 2013 and replaced by the N5380B 12 GHz SMA head.

Table 16 Bandwidth

| Probe Amplifier | BW (GHz) | Probe Amplifier | BW (GHz) |
|-----------------|----------|-----------------|----------|
| 1130A           | >1.5     | 1132A           | >5       |
| 1131A           | ~3.5     | 1134A           | >5.2     |



**PERFORMANCE PLOTS.** Refer to “N5380B SMA Probe Head” on page 199.

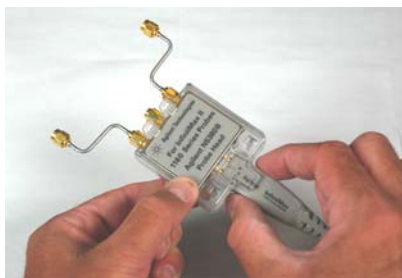
### Disconnecting the N5380B

When disconnecting a probe amplifier from the N5380B SMA probe head, grasp the probe amplifier as shown in Figure 24 on page 57 and pull it straight away from the SMA probe head without any rocking (either side-to-side or up-and-down).

### CAUTION

Pulling on the probe amplifier cable or strain relief, or rocking the probe amplifier to remove it, may damage the probe head or probe amplifier.

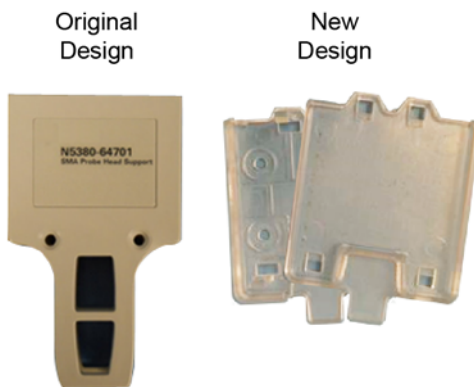




**Figure 24** Disconnecting the N5380B

### N5380A/B Head Support

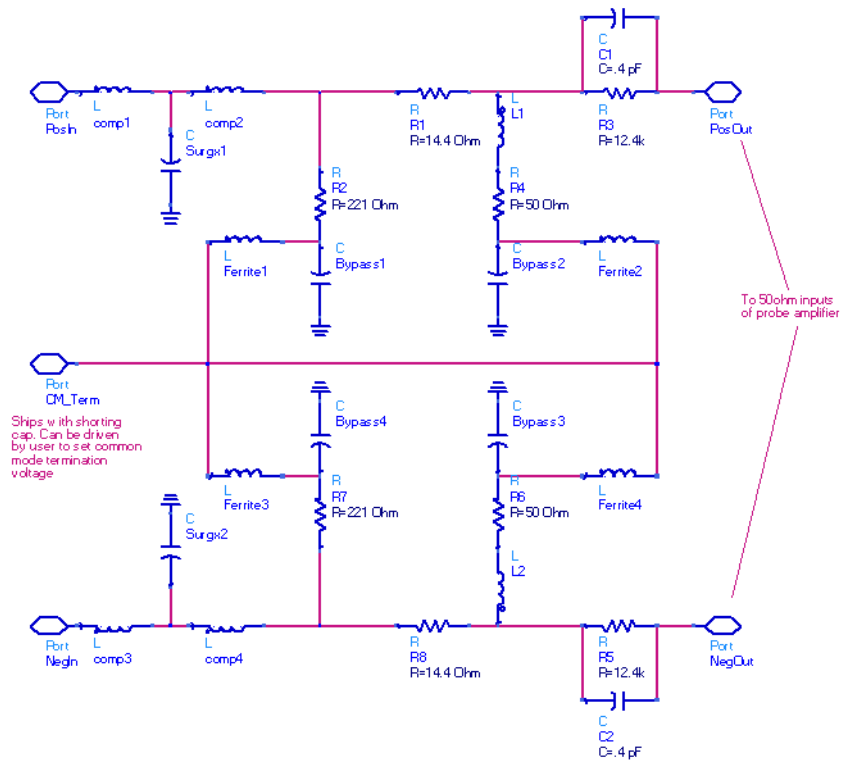
The probe amplifier can become damaged if the N5380A/B does not have an N5380-64701 SMA head support attached. N5380B heads come with the SMA head support already attached. For older N5380A heads, the head support can be ordered. As shown in [Figure 25](#), the current design of the N5380-64701 has been changed from the original design. The original design is no longer offered. Both the original and new design provide the same level of protection for the probe amplifier and can be attached to both N5380B and N5380A heads.



**Figure 25** Original and New Head Support Designs

## 2 Using Probe Heads

### Recommended Configurations at a Glance



**Figure 26 N5380B Schematic**

## 5 E2679A Single-Ended Solder-In Head

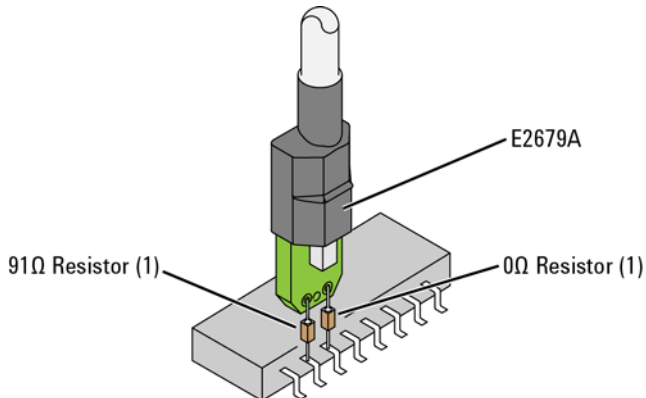
Full BW



The E2679A probe head provides good bandwidth measurements of single-ended signals only with a probe head that is physically very small. The probe head resistors must be soldered to the circuit that you are measuring. Because of the small size of the resistor leads, it is easy to solder them to very small geometry circuits.

**Table 17 Bandwidth**

| Probe Amplifier | BW (GHz) | Probe Amplifier | BW (GHz) |
|-----------------|----------|-----------------|----------|
| 1130A           | >1.5     | 1132A           | >5       |
| 1131A           | ~3.5     | 1134A           | >5.2     |



**Figure 27 E2679A**



**TO INSTALL OR REPAIR RESISTOR LEADS.** Refer to “Replacing Resistors on E2677A/9A Solder-In Probe Heads” on page 71.

## 2 Using Probe Heads

### Recommended Configurations at a Glance



**PERFORMANCE PLOTS.** Refer to [Chapter 5](#), “1130A Performance Data Plots”, [Chapter 6](#), “1131A Performance Data Plots”, [Chapter 7](#), “1132A Performance Data Plots”, and [Chapter 8](#), “1134A Performance Data Plots”.

## 6 E2676A Single-Ended Browser

General Purpose

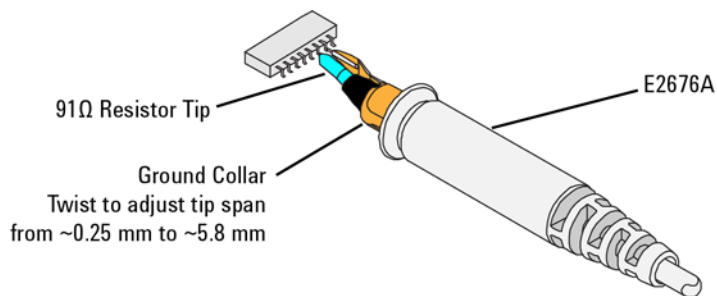


The E2676A single-ended browser is a good general purpose probing of single-ended signals when physical size is critical. This browser has lower bandwidth than the differential browser, but is very small which allows probing in tight areas.

**Table 18 Bandwidth**

| Probe Amplifier | BW (GHz) | Probe Amplifier | BW (GHz) |
|-----------------|----------|-----------------|----------|
| 1130A           | >1.5     | 1132A           | >5       |
| 1131A           | ~3.5     | 1134A           | >5.5     |

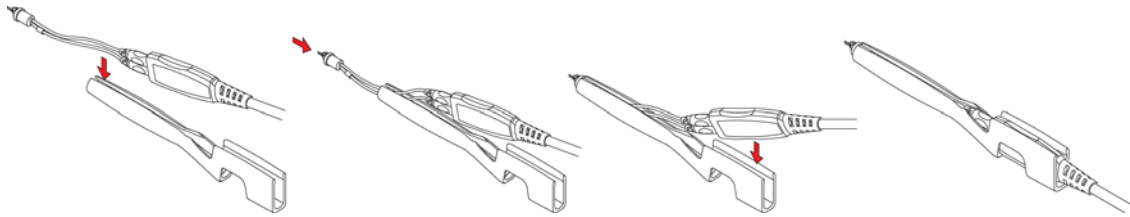
For wider span, non-performance critical browsing (rise times greater than  $\sim 0.5$  ns), the 5063-2120 socketed ground lead can be used in place of the 01130-60005 ground collar.



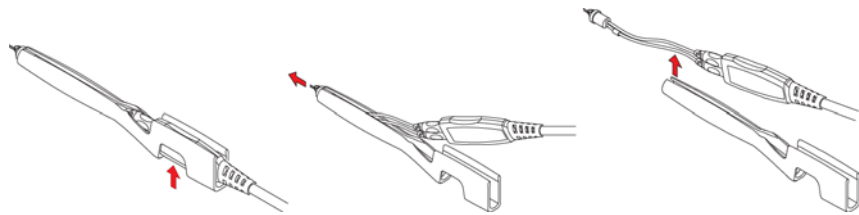
**Figure 28 E2676A**

When holding the E2675A for extended periods of time, use the supplied ergonomic handle. [Figure 29](#) and [Figure 30](#) show how to attach and remove the handle from the probe head.

**2 Using Probe Heads**  
Recommended Configurations at a Glance



**Figure 29 Inserting the Probe into the Handle**



**Figure 30 Removing the Probe from the Handle**

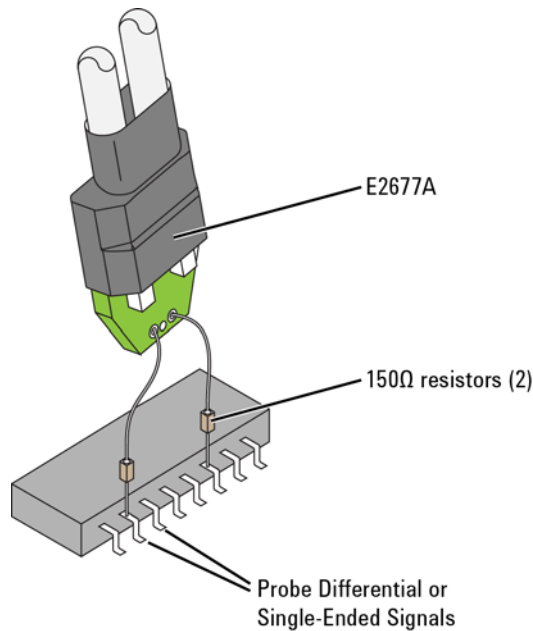
## 7 E2677A Differential Solder-In Head with Medium BW Resistors



The E2677A with medium BW resistors (150Ω mini-axial lead) probe configuration provides medium bandwidth measurements of differential or single-ended signals.

**Table 19 Bandwidth**

| Probe Amplifier | BW (GHz) | Probe Amplifier | BW (GHz) |
|-----------------|----------|-----------------|----------|
| 1130A           | >1.5     | 1132A           | ~2.9     |
| 1131A           | ~2.9     | 1134A           | ~2.9     |



**Figure 31 Solder-in Differential Probe Head (Medium Bandwidth)**

## 2 Using Probe Heads

### Recommended Configurations at a Glance

The longer resistor length allows connection to widely spaced points or points in tight areas. The probe head resistors must be soldered to the circuit that you are measuring. Because of the small size of the resistor leads, it is easy to solder them to very small geometry circuits. This configuration can probe circuit points that are farther apart than the full bandwidth configurations.



**TO INSTALL OR REPAIR RESISTOR LEADS.** Refer to “Replacing Resistors on E2677A/9A Solder-In Probe Heads” on page 71.



**PERFORMANCE PLOTS.** Refer to [Chapter 5](#), “1130A Performance Data Plots”, [Chapter 6](#), “1131A Performance Data Plots”, [Chapter 7](#), “1132A Performance Data Plots”, and [Chapter 8](#), “1134A Performance Data Plots”.



## 8 E2679A Single-Ended Solder-In Head with Long Wire

Medium  
BW



The E2679A probe head with long wire leads provides medium bandwidth measurements of single-ended signals. The longer resistor lead length allows connection to widely spaced points or points in tight areas.

Table 20 Bandwidth

| Probe Amplifier | BW (GHz) | Probe Amplifier | BW (GHz) |
|-----------------|----------|-----------------|----------|
| 1130A           | >1.5     | 1132A           | ~2.9     |
| 1131A           | ~2.9     | 1134A           | ~2.9     |

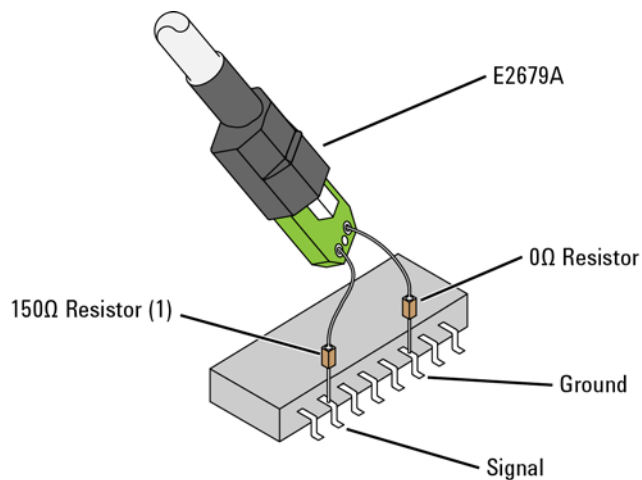


Figure 32 E2679A (Medium Bandwidth)

## 2 Using Probe Heads

### Recommended Configurations at a Glance

The probe head resistors must be soldered to the circuit that you are measuring. Because of the small size of the resistor leads, it is easy to solder them to very small geometry circuits. This configuration can probe circuit points that are farther apart than the full bandwidth configurations.



**TO INSTALL OR REPAIR RESISTOR LEADS.** Refer to “Replacing Resistors on E2677A/9A Solder-In Probe Heads” on page 71.

## 9 E2678A Differential Socketed Head with Damped Wire Accessory

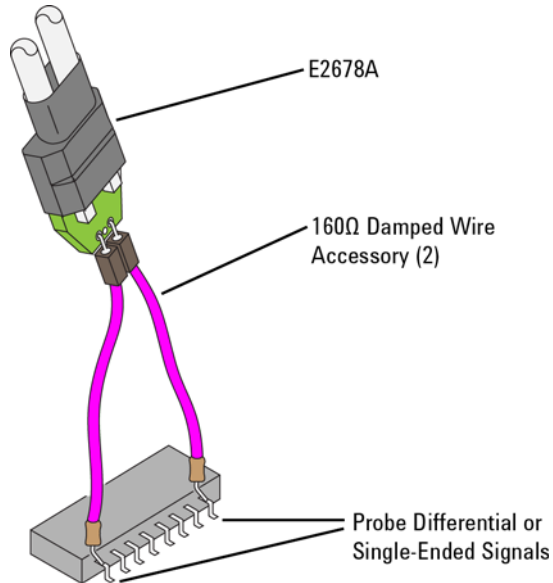
Reach & Flexibility



This E2678A probe configuration provides maximum connection reach and flexibility with good signal fidelity but lower bandwidth for measuring differential or single-ended signals.

**Table 21 Bandwidth**

| Probe Amplifier | BW (GHz) | Probe Amplifier | BW (GHz) |
|-----------------|----------|-----------------|----------|
| 1130A           | ~1.2     | 1132A           | ~1.2     |
| 1131A           | ~1.2     | 1134A           | ~1.2     |



**Figure 33 E2678A with Damped Wire Accessory**

## 2 Using Probe Heads

### Recommended Configurations at a Glance

The damped wires must be soldered to the circuit that you are measuring. This configuration can probe circuit points that are farther apart than other configurations. This probe head come with a damped wire accessory that includes two 160Ω resistors.



**PERFORMANCE PLOTS.** Refer to [Chapter 5](#), “1130A Performance Data Plots”, [Chapter 6](#), “1131A Performance Data Plots”, [Chapter 7](#), “1132A Performance Data Plots”, and [Chapter 8](#), “1134A Performance Data Plots”.

## 10 E2678A Differential Socketed Head with Header Adapter

This probe configuration can be used to connect to 25 mil square pin headers with 100 mil spacing such as those used in USB testing. The header adapter is recommended for use with the 1130A and 1131A InfiniiMax probes.

**NOTE**

If the header adapter is used with higher bandwidth probe amplifiers such as the 1132A (5 GHz) or the 1134A (7GHz), the rise time of the input signal should be slower than ~150 ps (10% to 90%) to limit the effects of resonances in the adapter.

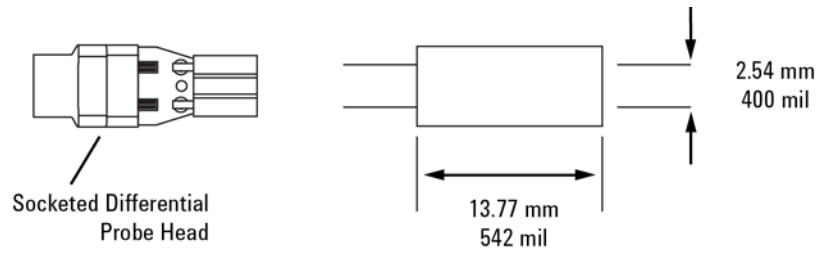
All of the specifications and characteristics of the header adapter are the same as those for the socketed differential probe head except for the input capacitance shown in Table 22.

**Table 22 Characteristic Capacitance**

| Identification          | Capacitance | Description  |
|-------------------------|-------------|--|
| <b>C<sub>m</sub></b>    | 0.43 pF     | Model for input C is C <sub>m</sub> between the tips and C <sub>g</sub> to ground each tip |
| <b>C<sub>g</sub></b>    | 0.54 pF     |  |
| <b>C<sub>diff</sub></b> | 0.70 pF     | Differential mode capacitance is C <sub>m</sub> + C <sub>g</sub> /2                        |
| <b>C<sub>se</sub></b>   | 0.97 pF     | Single-ended mode capacitance is C <sub>m</sub> + C <sub>g</sub>                           |

To adapt the 01130-21302 damped wire accessory from solder-in to plug-on, solder the tip into the 01131-85201 square pin socket and then slip the 01131-41101 heat-shrink sleeve over the solder joint and heat the heat-shrink tubing with a heat gun. This allows the damped wire accessories to be used to plug onto 25 mil square pins.

**2 Using Probe Heads**  
Recommended Configurations at a Glance



**Figure 34 01130-63201 Header Adapter Dimensions**

## Replacing Resistors on E2677A/9A Solder-In Probe Heads

Use the following procedure to install or replace the wire leads when the mini-axial resistors become damaged or break off due to use.

**Table 23 Resistors and Bandwidth**

| Resistor     | For Bandwidth   |
|--------------|-----------------|
| 91 $\Omega$  | Full            |
| 150 $\Omega$ | Medium          |
| 0 $\Omega$   | Full and Medium |

**NOTE**

Resistor performance. The 91 $\Omega$  resistors were changed from 100 $\Omega$  to 91 $\Omega$  for slightly better performance. Either value produces a response that is well within specifications.

**Table 24 Recommended Equipment**

| Equipment  |
|--|
| Vise or clamp for holding tip  |
| Metcal STTC-022 (600 °C) or STTC-122(700 °C) tip soldering iron or equivalent. The 600 °C tip will help limit burning of the FR4 tip PC board. |
| 0.381 mm (0.015 in) diameter RMA flux standard tin/lead solder wire  |
| Fine stainless steel tweezers  |
| Rosin flux pencil, RMA type (Kester #186 or equivalent)  |
| Diagonal cutters   |
| Magnifier or low power microscope  |
| Agilent supplied trim gauge (01131-94311)  |

## 2 Using Probe Heads

### Replacing Resistors on E2677A/9A Solder-In Probe Heads

#### Procedure

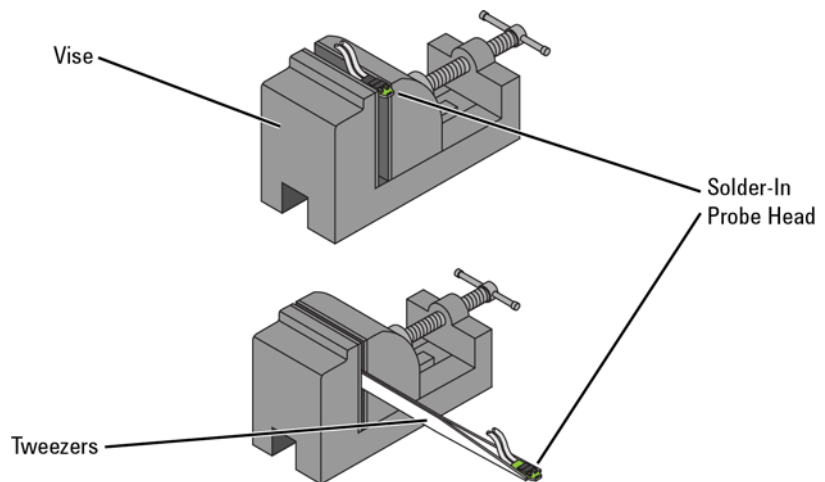
- 1 Use the vise or clamp to position the tip an inch or so off the work surface for easy access.

---

#### CAUTION

If using a vise, grip the tip on the sides with light force. When tightening the vise, use light force to avoid damaging the solder-in probe head. If using a tweezers clamp, grip the tip either on the sides or at the top and bottom.

---



**Figure 35 Clamping the Probe Head**

- 2 If you need to remove an existing or damaged lead wire, grab each resistor lead or body with tweezers and pull very gently up. Touch the soldering iron to the solder joint just long enough for the resistor to come free of the probe head tip.

---

#### CAUTION

To avoid burning and damage to the pc board, do not keep the soldering iron in contact with the tip any longer than necessary. The solder joint has very low thermal mass, so the joint quickly melts and releases the wire.

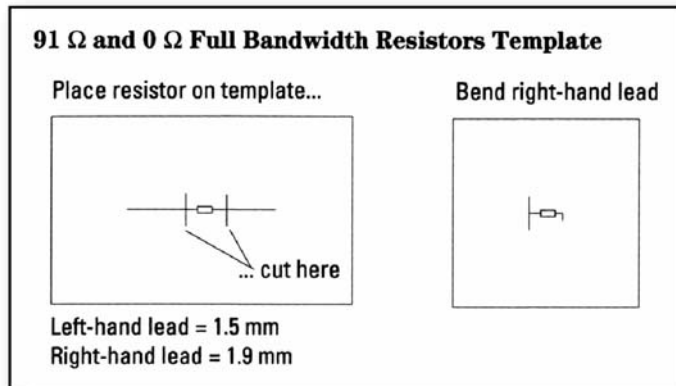
---



**NOTE**

Make sure soldering iron tip is free of excess solder.

- 3 In needed, fill the mounting hole with solder in preparation for the new wire.
- 4 Use the flux pencil to coat the solder joint area with flux.
- 5 Prepare the mini-axial lead resistor for attachment to the head's pc board. The lead to be attached to head's pc board will have a 90° bend to go into through hole in the tip pc board.
- 6 Using tweezers, place the resistor body inside the rectangle of the trim template.

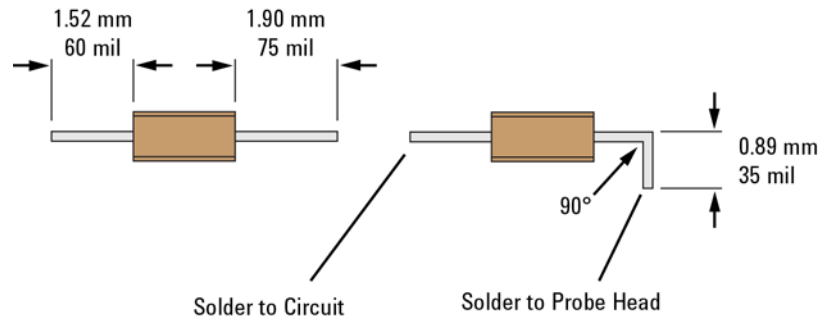


**Figure 36** Agilent Supplied Template Included With Resistors

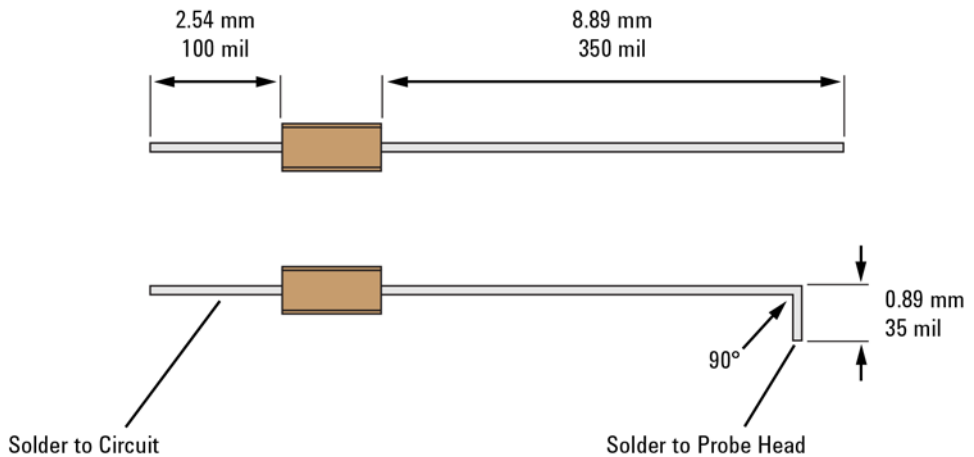
- 7 Using a knife, trim the leads even with the trim lines.
- 8 Place resistor body inside the rectangle of the bend template.
- 9 Using another pair of tweezers, bend the 1.90 mm or 8.89 mm lead 90° as shown in [Figure 37](#) and [Figure 38](#).

## 2 Using Probe Heads

### Replacing Resistors on E2677A/9A Solder-In Probe Heads



**Figure 37** 91 $\Omega$  and 0 $\Omega$  Combination Resistor Trim Dimensions



**Figure 38** 150 $\Omega$  and 0 $\Omega$  Combination Resistor Trim Dimensions

---

#### NOTE

---

Do not use the wrong value of resistor at the wrong length.

- 10 Holding the resistor lead or wire in one hand and soldering iron in the other, position the end of the resistor lead (after the 90° bend) over the solder filled hole. Touch the soldering iron to the side of the hole. When the solder in the hole

## Replacing Resistors on E2677A/9A Solder-In Probe Heads

melts, the resistor lead will fall into the hole. Remove soldering iron as soon as lead falls into the hole.

---

**CAUTION**

The thermal mass of the joint is very small, so taking extra time with the soldering iron in an attempt to ensure a good joint is not needed.

---

**NOTE**

Make sure the zero ohm resistor is used for ground leads on the E2679A single-ended probe head.

---

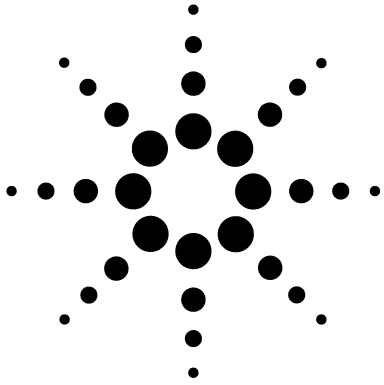
**NOTE**

For the E2677A differential solder-in probe head, the + and – connection can be determined when the probe head is plugged into the probe amplifier, so which way the tip is soldered in is not important.

---

## **2 Using Probe Heads**

### **Replacing Resistors on E2677A/9A Solder-In Probe Heads**



## 3

# Calibrating Probes

Calibration for Solder-In and Socketed Probe Heads 78

Calibration for Hand-held Browser Probe Heads 86

Calibrating the InfiniiMax probes (1168A, 1169A, 1130A, 1131A, 1132A, 1134A), the 1156A probe, the 1157A probe, or the 1158A probe is done using the E2655C Deskew and Calibration Kit. The kit contains the following parts:

- SMA (male) to SMA (male) adaptor
- SMA (male) to BNC (female) adaptor
- BNC (male) to SMA (male) adaptor
- 50Ω SMA Terminator
- De-skew Fixture

When the probe has been calibrated, the dc gain, offset zero, and offset gain will be calibrated. The degree of accuracy specified at the probe tip is dependent on the oscilloscope system specifications.

This document contains procedures showing vertical and skew calibration solder-in differential probe head and the differential browser probe head. The procedures can also be applied to all of the different InfiniiMax probe configurations and for the 11560 and 1150A series active probe configurations.

---

## Calibration for Solder-In and Socketed Probe Heads

Calibration of the solder-in and socketed probe heads consists of a vertical calibration and a skew calibration. The vertical calibration should be performed before the skew calibration. Both calibrations should be performed for best probe measurement performance.

---

#### NOTE

Before calibrating the probe, verify that the Infiniium oscilloscope has been calibrated recently and that the calibration D temperature is within  $\pm 5^{\circ}\text{C}$ . If this is not the case, calibrate the oscilloscope before calibrating the probe. This information is found in the Infiniium Calibration dialog box.

---

### Step 1. Connecting the Probe for Calibration

The calibration procedure requires the following parts.

- BNC (male) to SMA (male) adaptor
- Deskew fixture
- $50\Omega$  SMA terminator

- 1 As shown in [Figure 39](#) on page 80, connect BNC (male) to SMA (male) adaptor to the deskew fixture on the connector closest to the yellow pincher.
- 2 Connect the  $50\Omega$  SMA terminator to the connector farthest from the yellow pincher.
- 3 Connect the BNC side of the deskew fixture to the Aux Out BNC of the Infiniium oscilloscope.
- 4 Connect the probe to an oscilloscope channel.
- 5 To minimize the wear and tear on the probe head, the probe head should be placed on a support to relieve the strain on the probe head cables.
- 6 Push down on the back side of the yellow pincher. Insert the probe head resistor lead underneath the center of the yellow pincher and over the center conductor of the deskew fixture. The negative probe head resistor lead or ground lead must

be underneath the yellow pincher and over one of the outside copper conductors (ground) of the deskew fixture. Make sure that the probe head is approximately perpendicular to the deskew fixture.

---

**NOTE**

For the socketed probe head, insert two properly trimmed 82  $\Omega$  resistors into the sockets.

---

**7**

Release the yellow pincher.

---

**NOTE**

To ensure contact, pull up on the back side of the yellow pincher to ensure good contact between resistor leads and the deskew fixture.

---

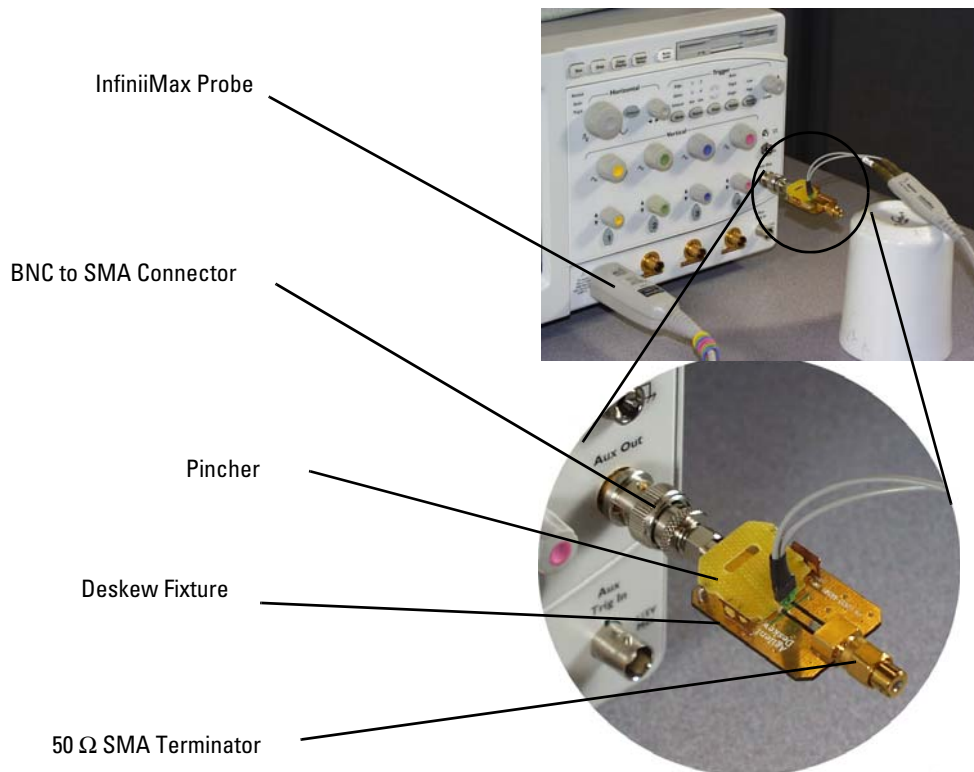
## Step 2. Verifying the Connection

- 1 On the Infiniium oscilloscope, press the autoscale button on the front panel.
- 2 Set the volts per division to 100 mV/div.
- 3 Set the horizontal scale to 1.00 ns/div.
- 4 Set the horizontal position to approximately 3 ns. You should see a waveform similar to that in [Figure 40](#).

If you see a waveform similar to that of [Figure 41](#), then you have a bad connection and should check all of your probe connections.

### 3 Calibrating Probes

#### Calibration for Solder-In and Socketed Probe Heads



**Figure 39** Connecting the Probe and Deskew Fixture



Calibration for Solder-In and Socketed Probe Heads

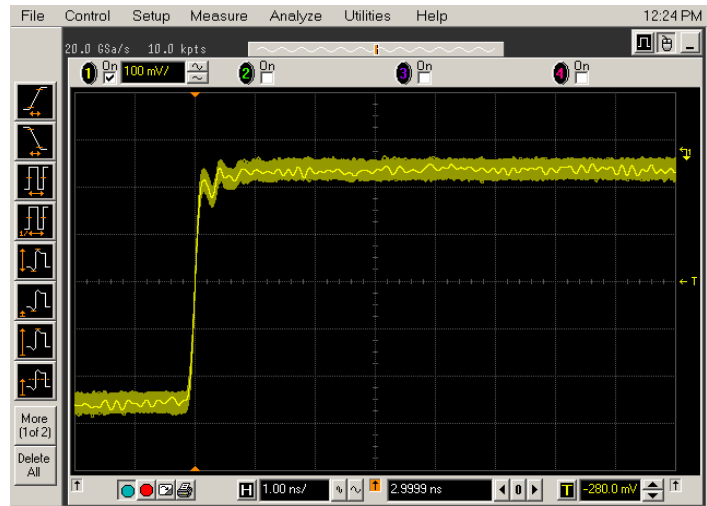


Figure 40 Good Connection

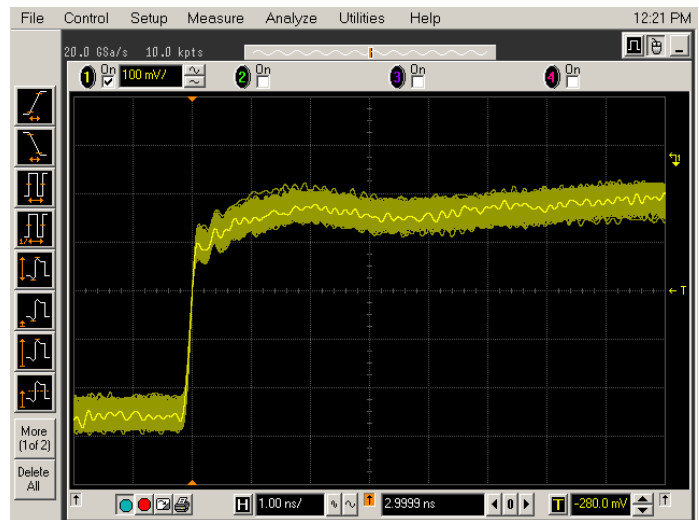


Figure 41 Bad Connection

### 3 Calibrating Probes

#### Calibration for Solder-In and Socketed Probe Heads

### Step 3. Running the Probe Calibration and Deskew

- 1 On the Infiniium oscilloscope in the Setup menu, select the channel connected to the probe.
- 2 In the Channel Setup dialog box select the Probes... button.
- 3 In the Probe Setup dialog box select the Calibrate Probe... button.
- 4 In the Probe Cal dialog box select the Calibrated Atten/Offset radio button.
- 5 Select the Start Atten/Offset Calibration... button and follow the on-screen instructions for the vertical calibration procedure.
- 6 Once the vertical calibration has successfully completed, select the Calibrated Skew... button.
- 7 Select the Start Skew Calibration... button and follow the on-screen instructions for the skew calibration. At the end of each calibration the oscilloscope will inform you if the calibration was or was not successful.

### Verifying the Probe Calibration

If you have just successfully calibrated the probe, it is not necessary to perform this verification. However, if you want to verify the probe was properly calibrated, the following procedure will help you verify the calibration.

The calibration procedure requires the following parts.

- BNC (male) to SMA (male) adaptor
- SMA (male) to BNC (female) adaptor
- BNC (male) to BNC (male) 12 inch cable such as the Agilent 8120-1838 (not included in this kit)
- Agilent 54855-61620 calibration cable (Infiniium oscilloscopes with bandwidths of 6 GHz and greater only)
- Agilent 54855-67604 precision 3.5 mm adaptors (Infiniium oscilloscopes with bandwidths of 6 GHz and greater only)
- Deskew fixture

For the following procedure, refer to [Figure 39](#) on page 80.

- 1 As shown in [Figure 42](#) on page 84, connect BNC (male) to SMA (male) adapter to the deskew fixture on the connector closest to the yellow pincher.
- 2 Connect the SMA (male) to BNC (female) to the connector farthest from the yellow pincher.
- 3 Connect the BNC (male) to BNC (male) cable to the BNC connector on the deskew fixture to one of the unused oscilloscope channels. For Infiniium oscilloscopes with bandwidths of 6 GHz and greater, use the 54855-61620 calibration cable and the two 54855-67604 precision 3.5 mm adapters.
- 4 Connect the BNC side of the deskew fixture to the Aux Out BNC of the Infiniium oscilloscope.
- 5 Connect the probe to an oscilloscope channel.
- 6 To minimize the wear and tear on the probe head, the probe head should be placed on a support to relieve the strain on the probe head cables.
- 7 Push down on the back side of the yellow pincher. Insert the probe head resistor lead underneath the center of the yellow pincher and over the center conductor of the deskew fixture. The negative probe head resistor lead or ground lead must be underneath the yellow pincher and over one of the outside copper conductors (ground) of the deskew fixture. Make sure that the probe head is approximately perpendicular to the deskew fixture.

---

**NOTE**

For the socketed probe head, insert two properly trimmed 82  $\Omega$  resistors into the sockets.

---

**8**

Release the yellow pincher.

---

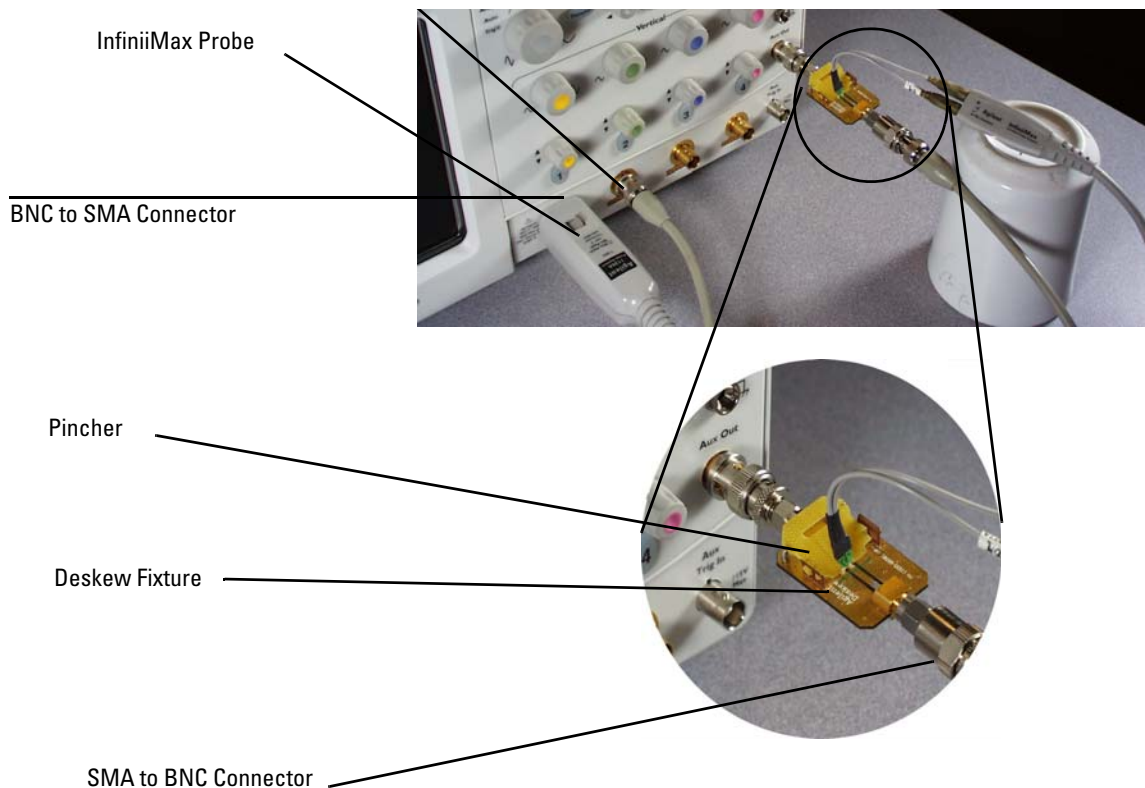
**NOTE**

To ensure contact, pull up on the back side of the yellow pincher to ensure good contact between resistor leads and the deskew fixture.

---

### 3 Calibrating Probes

#### Calibration for Solder-In and Socketed Probe Heads



**Figure 42 Connecting the Probe**

- 9** On the oscilloscope, press the autoscale button on the front panel.
- 10** Select Setup menu and choose the channel connected to the BNC cable from the pull-down menu.
- 11** Select the Probes... button.
- 12** Select the Configure Probe System button.
- 13** Select User Defined Probe from the pull-down menu.
- 14** Select the Calibrate Probe... button.

- 15 Select the Calibrated Skew radio button.
- 16 Once the skew calibration is completed, close all dialog boxes.
- 17 Select the Start Skew Calibration... button and follow the on-screen instructions.
- 18 Set the vertical scale for the displayed channels to 100 mV/div.
- 19 Set the horizontal range to 1.00 ns/div.
- 20 Set the horizontal position to approximately 3 ns.
- 21 Change the vertical position knobs of both channels until the waveforms overlap each other.
- 22 Select the Setup menu choose Acquisition... from the pull-down menu.
- 23 In the Acquisition Setup dialog box enable averaging. When you close the dialog box, you should see waveforms similar to that in Figure 43.



Figure 43 Overlapping Waveforms

---

## Calibration for Hand-held Browser Probe Heads

Calibration of the hand-held browser probe heads consists of a vertical calibration and a skew calibration. The vertical calibration should be performed before the skew calibration. Both calibrations should be performed for best probe measurement performance.

---

#### NOTE

Before calibrating the probe, verify that the Infiniium oscilloscope has been calibrated recently and that the calibration  $\Delta$  temperature is within  $\pm 5$  °C. If this is not the case, calibrate the oscilloscope before calibrating the probe. This information is found in Infiniium Calibration dialog box.

---

### Calibration Setup

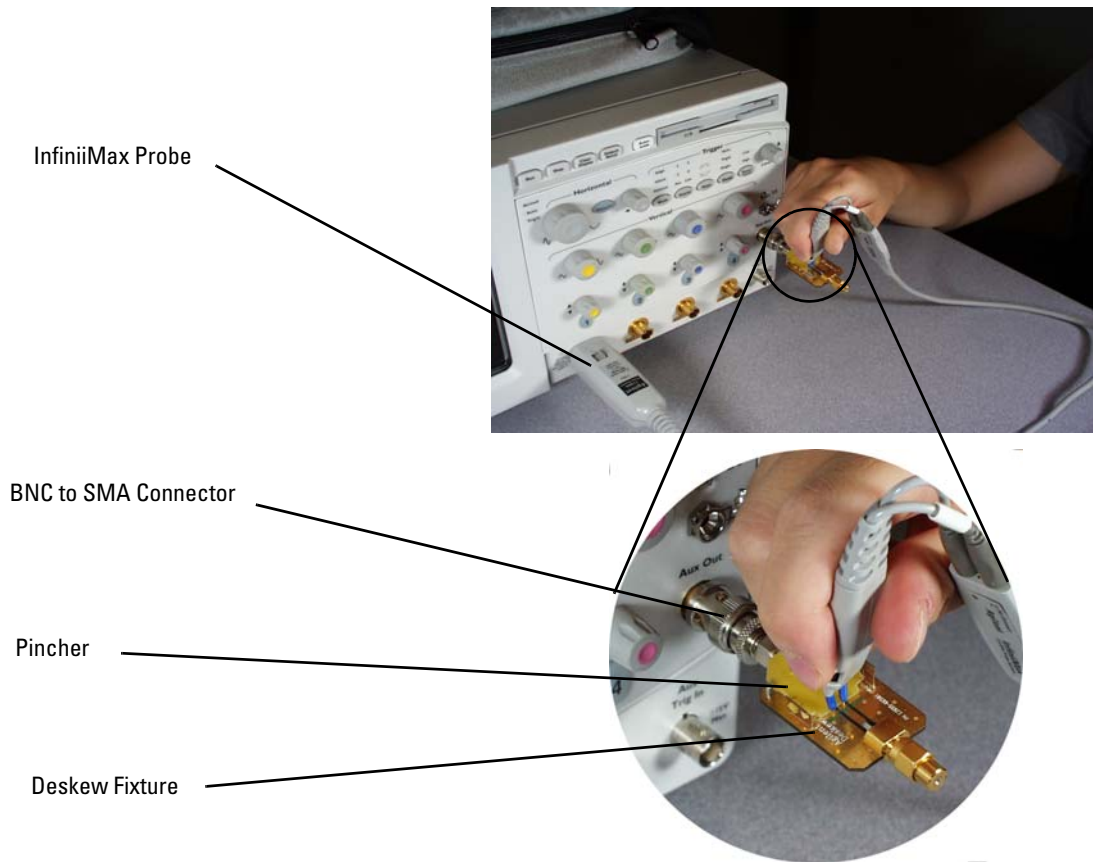
The calibration procedure requires the following parts.

- BNC (male) to SMA (male) adaptor
- Deskew fixture
- 50  $\Omega$  SMA terminator

- 1 As shown in [Figure 44](#) on page 88, connect BNC (male) to SMA (male) adaptor to the deskew fixture on the connector closest to the yellow pincher.
- 2 Connect the 50 $\Omega$  SMA terminator to the connector farthest from the yellow pincher.
- 3 Connect the BNC side of the deskew fixture to the Aux Out of the Infiniium oscilloscope.
- 4 Connect the probe to an oscilloscope channel.
- 5 Place the positive resistor tip of the browser on the center conductor of the deskew fixture between the green line and front end of the yellow pincher. The negative resistor tip or ground pin of the browser must be on either of the two outside conductors (ground) of the deskew fixture.
- 6 On the Infiniium oscilloscope in the Setup menu, select the channel connected to the probe.

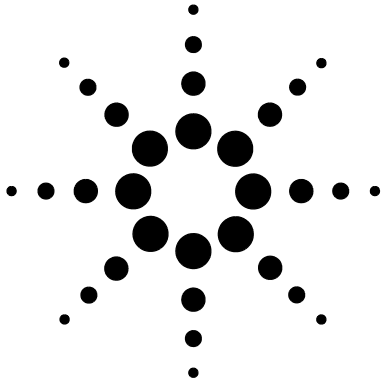
- 7** In the Channel Setup dialog box select the Probes... button.
- 8** In the Probe Setup dialog box select the Calibrate Probe... button.
- 9** In the Probe Cal dialog box select the Calibrated Atten/Offset radio button.
- 10** Select the Start Atten/Offset Calibration... button and follow the on-screen instructions for the vertical calibration procedure.
- 11** Once the vertical calibration has successfully completed, select the Calibrated Skew... button.
- 12** Select the Start Skew Calibration... button and follow the on-screen instructions for the skew calibration.

**3 Calibrating Probes**  
Calibration for Hand-held Browser Probe Heads



**Figure 44** Placing the Probe on the Fixture





## 4

# Characteristics and Specifications

|                  |    |
|------------------|----|
| General          | 90 |
| Environmental    | 92 |
| Regulatory       | 93 |
| Probe Dimensions | 94 |

All warranted specifications are denoted by a footnote reference number. All other characteristics are typical values.

## General

**Table 25 Characteristics and Specifications (Sheet 1 of 2)**

| Item  | Characteristic <sup>a</sup>            | Description   |
|---|--|---|
| Bandwidth (–3 dB) (specification)               |  |   |
| 1134A   | > 7 GHz (specification) <sup>b</sup>   |   |
| 1132A   | > 5 GHz (specification) <sup>b</sup>   |   |
| 1131A   | > 3.5 GHz (specification) <sup>b</sup> |   |
| 1130A   | > 1.5 GHz (specification) <sup>b</sup> |   |
| Rise and Fall Time (10% to 90%)                 |  |   |
| 1134A   | 60 ps                                  |   |
| 1132A   | 86 ps                                  |   |
| 1131A   | 100 ps                                 |   |
| 1130A   | 233 ps                                 |   |
| Oscilloscope and Probe System Bandwidth (–3 dB) |  |   |
| 1134A with 54855                                | 6 GHz                                  |   |
| 1132A with 54854                                | 4 GHz                                  |   |
| 1131A with 54853                                | 2.5 GHz                                |   |
| 1131A with 54852                                | 2 GHz                                  |   |
| 1130A with 54833                                | 1 GHz                                  |   |
| 1130A with 54832                                | 1 GHz                                  |   |
| Input Capacitance                               |  |   |
| C <sub>m</sub>                                  | 0.10 pF                                | Model for input C is C <sub>m</sub> is between tips and C <sub>g</sub> is to ground for each tip                    |
| C <sub>g</sub>                                  | 0.34 pF                                |   |
| C <sub>diff</sub>                               | 0.27 pF                                | Differential mode capacitance (capacitance when probing a differential signal = C <sub>m</sub> + C <sub>g</sub> /2) |
| C <sub>se</sub>                                 | 0.44 pF                                | Single-ended mode capacitance (capacitance when probing a single-ended signal = C <sub>m</sub> + C <sub>g</sub> )   |

**Table 25 Characteristics and Specifications (Sheet 2 of 2)**

| Item   | Characteristic <sup>a</sup>                        | Description  |
|--|--|--|
| Input Resistance   |  |  |
| Differential mode resistance                               | 50 kΩ ±2%  |  |
| Single-ended mode resistance each side to ground           | 25 kΩ ±2%  |  |
| Input Dynamic Range  | ±2.5 V   | Differential or single-ended                         |
| Input Common Mode Range                                    | ±6.75 V  | dc to 100 Hz   |
|  | ±1.25 V  | > 100 Hz   |
| Maximum Signal Slew Rate (SR <sub>max</sub> ) <sup>c</sup> | 18 V/ns  | When probing a single-ended signal                   |
|  | 30 V/ns  | When probing a differential signal                   |
| DC Attenuation   | 10:1 ±3% before calibration on oscilloscope        |  |
|  | 10:1 ±1% after calibration on oscilloscope         |  |
| Zero offset error referred to input                        | < 30 mV before calibration on oscilloscope         |  |
|  | < 5 mV after calibration on oscilloscope           |  |
| Offset Range   | ±12.0 V  | When probing single-ended                            |
| Offset Accuracy  | < 3% of setting before calibration on oscilloscope |  |
|  | < 1% of setting after calibration on oscilloscope  |  |
| Noise referred to input                                    | 3.0 mVrms  |  |
| Propagation Delay  | 6 ns   |  |
| Maximum Input Voltage                                      | 30 V Peak, CAT I                                   | Maximum non-destructive voltage on each input ground |
| ESD Tolerance  | > 8 kV from 100 pF, 300 Ω HBM                      |  |

- a Values shown are for the probe amp and solder-in differential probe head with full bandwidth resistor.
- b Denotes that bandwidth is a warranted specification, all others are typical. Measured using the probe amplifier and solder-in differential probe head with full bandwidth resistor.
- c SR<sub>max</sub> of a sine wave = 2 II(Amp x frequency or SR<sub>max</sub>) of a step @ Amp x 0.6 / trise (20 to 80%) for more information refer to [Table 11](#) on page 36.

## Environmental

The following general characteristics apply to the active probe.

**Table 26 Environmental Characteristics**

| Environmental Conditions                                      | Operating Characteristic  | Non-Operating Characteristic          |
|---|---|---------------------------------------|
| Temperature   | 5 °C to +40 °C  | –40 °C to +70 °C                      |
| Humidity  | up to 95% relative humidity (non-condensing) at +40 °C  | up to 90% relative humidity at +65 °C |
| Altitude  | Up to 4,600 meters  | Up to 15,300 meters                   |
| Power Requirements (voltages supplied by AutoProbe Interface) | +12 Vdc @ 11 mA<br>–12 Vdc @ 5 mA<br>+5 Vdc @ 28 mA<br>–5 Vdc @ 92 mA<br>0.84 W   | —                                     |
| Weight  | approximately 0.69 kg   |                                       |
| Dimensions  | Refer to the outline in <a href="#">Figure 45</a> on page 94  |                                       |
| Pollution degree 2  | Normally only non-conductive pollution occurs. Occasionally, however, a temporary conductivity caused by condensation must be expected. |                                       |
| Use   | Indoor Only   |                                       |

---

## Regulatory

### CAT I and CAT II Definitions

Installation category (overvoltage category) I: Signal level, special equipment or parts of equipment, telecommunication, electronic, etc., with smaller transient overvoltages than installation category (overvoltage category) II. Installation category (overvoltage category) II: Local level, appliances, portable equipment etc., with smaller transient overvoltages than installation category (overvoltage category) III.

### WEEE Compliance

This product complies with the WEEE Directive (2002/96/EC) marking requirements. The affixed label indicates that you must not discard this electrical/electronic product in domestic household waste.



Product Category: With reference to the equipment types in the WEEE Directive Annex I, this product is classed as a "Monitoring and Control Instrumentation" product.

Do not dispose in domestic household waste. To return unwanted products, contact your local Agilent office, or see [www.agilent.com](http://www.agilent.com) for more information.

## Probe Dimensions

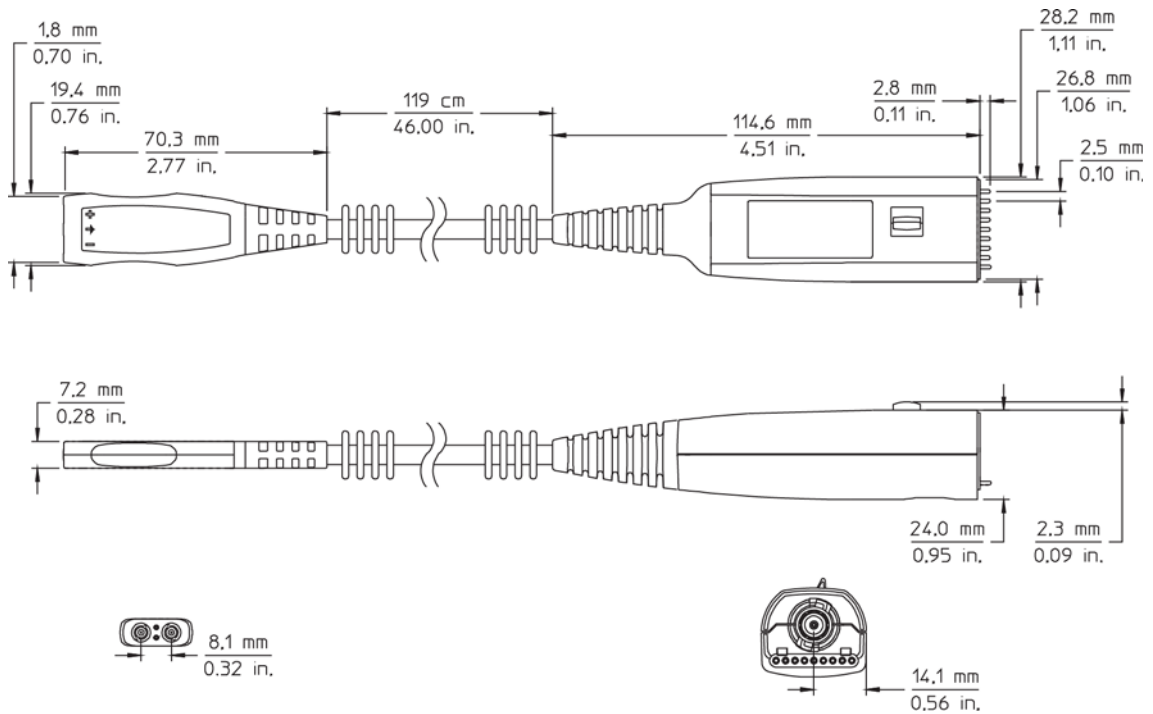
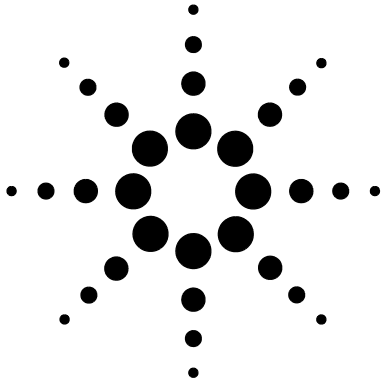


Figure 45 Probe Dimensions



## 5

# 1130A Performance Data Plots

|  |     |
|--|-----|
| E2675A Differential Browser  | 96  |
| E2676A Single-Ended Browser  | 99  |
| E2677A Differential Solder-in Probe Head (Full BW)                 | 102 |
| E2677A Differential Solder-in Probe Head (Medium BW)               | 105 |
| E2678A Differential Socketed Probe Head (Full BW)                  | 108 |
| E2678A Differential Socketed Probe Head with Damped Wire Accessory | 111 |
| E2679A Single-Ended Solder-in Probe Head (Full BW)                 | 115 |
| E2679A Single-Ended Solder-in Probe Head (Medium BW)               | 118 |

This chapter provides graphs of the performance characteristics of the 1130A probes using the different probe heads that come with the E2668A single-ended and E2669A differential connectivity kits.

---

### NOTE

---

All rise times shown are measured from the 10% to the 90% amplitude levels.

## E2675A Differential Browser

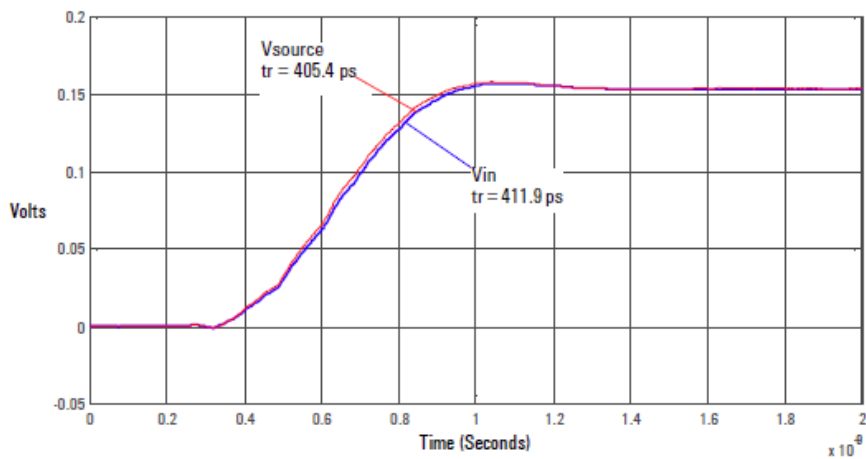


Figure 46 Graph of 25 ohm 405.4 ps step generator with and without probe connected.

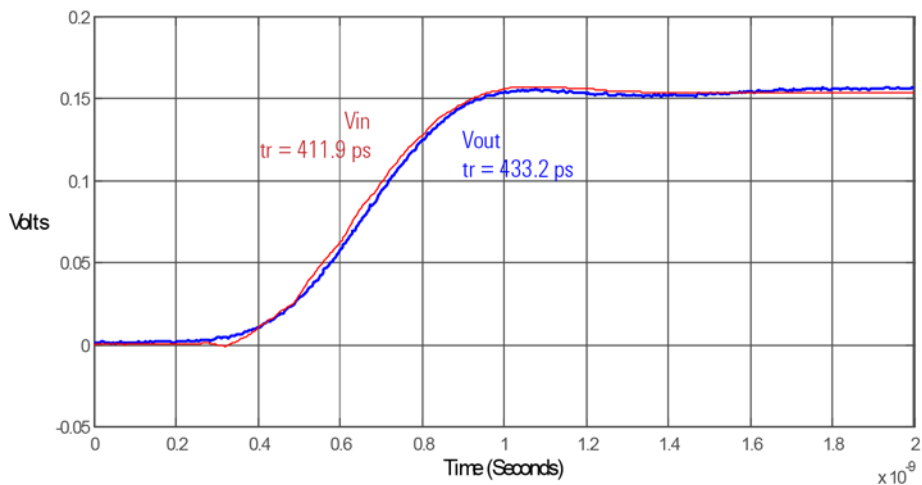


Figure 47 Graph of Vin and Vout of probe with a 25 ohm 405.4 ps step generator.



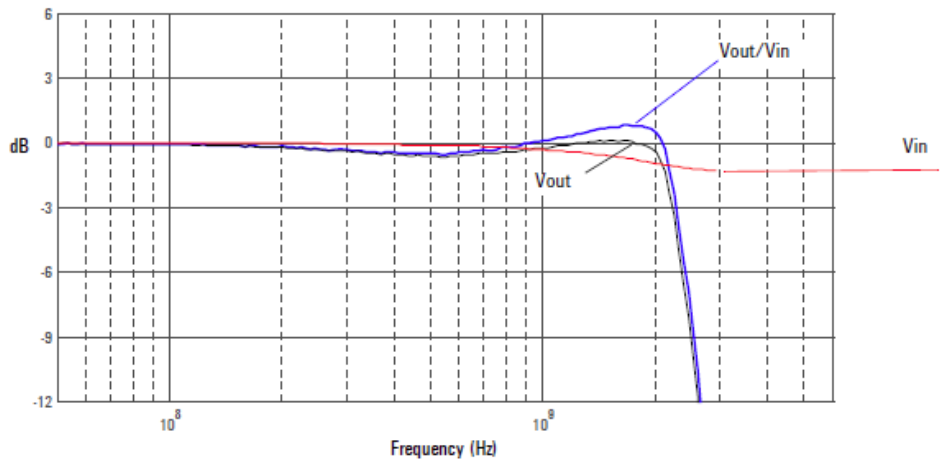


Figure 48 Graph of  $V_{in}$  and  $V_{out}$  of probe with a 25 ohm source and  $V_{out}/V_{in}$  frequency response.

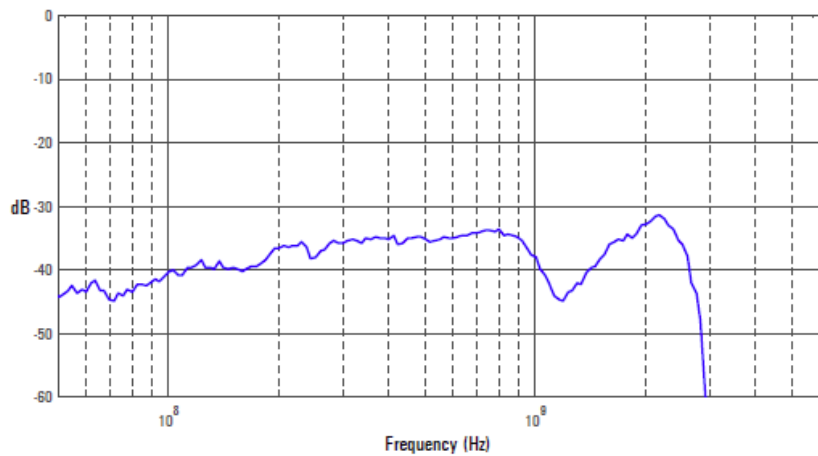


Figure 49 Graph of  $V_{out}/V_{in}$  frequency response when inputs driven in common (common mode rejection).

5 1130A Performance Data Plots  
E2675A Differential Browser

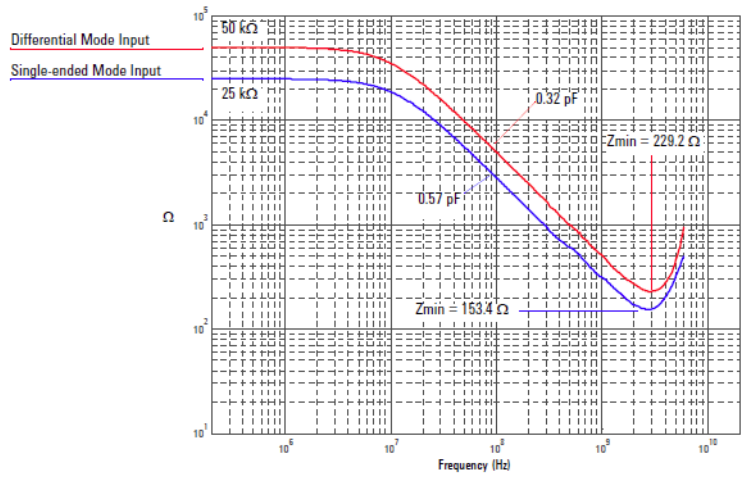


Figure 50 Magnitude plot of probe input impedance versus frequency.

## E2676A Single-Ended Browser

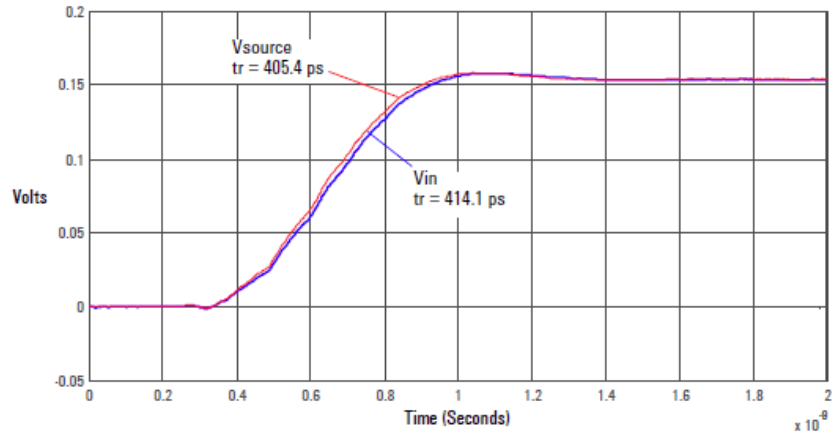


Figure 51 Graph of 25 ohm 405.4 ps step generator with and without probe connected.

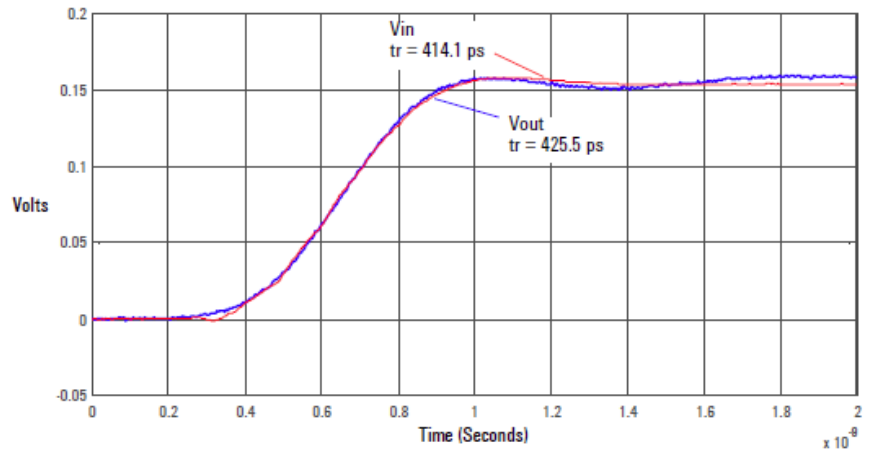
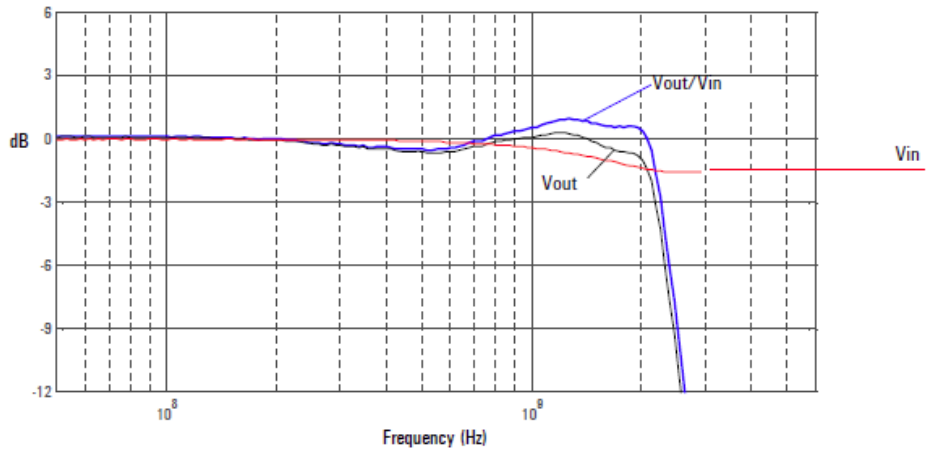
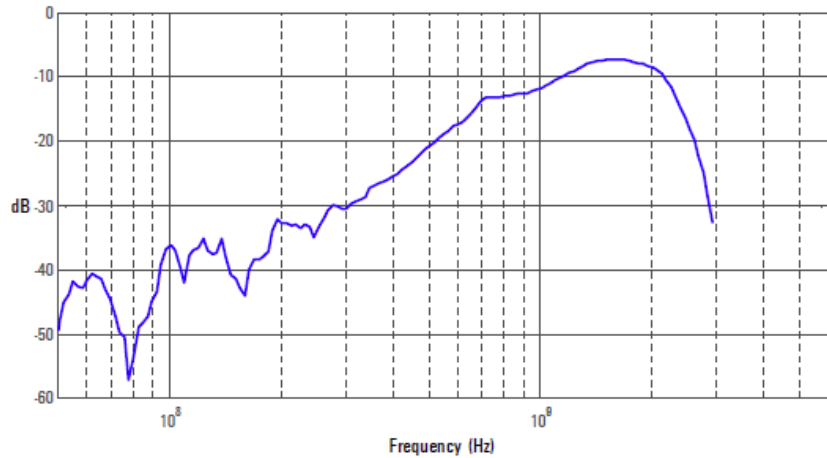


Figure 52 Graph of Vin and Vout of probe with a 25 ohm 405.4 ps step generator.

**5 1130A Performance Data Plots**  
E2676A Single-Ended Browser



**Figure 53** Graph of  $V_{in}$  and  $V_{out}$  of probe with a 25 ohm source and  $V_{out}/V_{in}$  frequency response.



**Figure 54** Graph of  $V_{out}/V_{in}$  frequency response when inputs driven in common (common mode rejection).

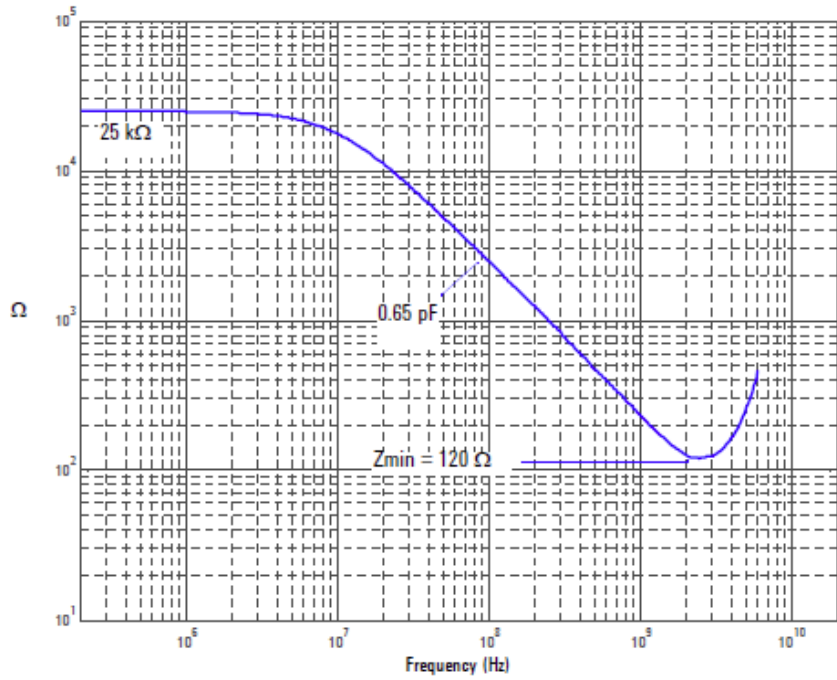


Figure 55 Magnitude plot of probe input impedance versus frequency.

## E2677A Differential Solder-in Probe Head (Full BW)

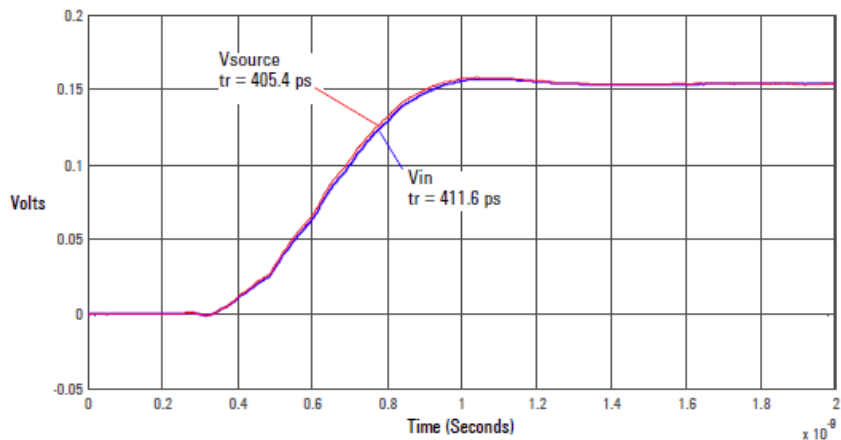


Figure 56 Graph of 25 ohm 100 ps step generator with and without probe connected.

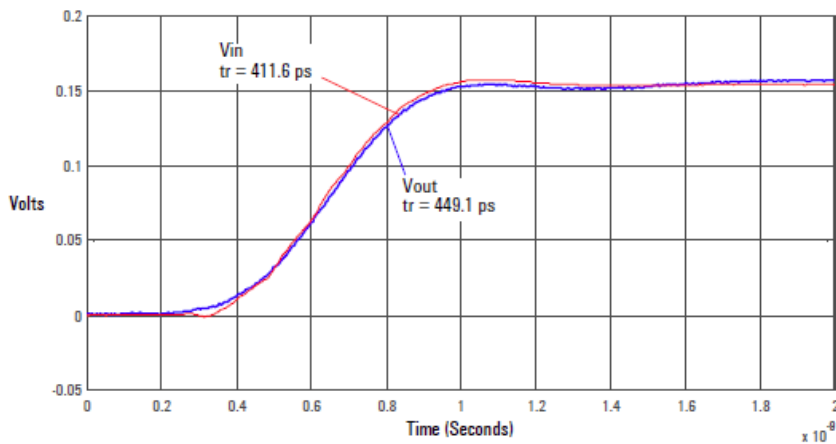


Figure 57 Graph of  $V_{in}$  and  $V_{out}$  of probe with a 25 ohm 405.4 ps step generator.

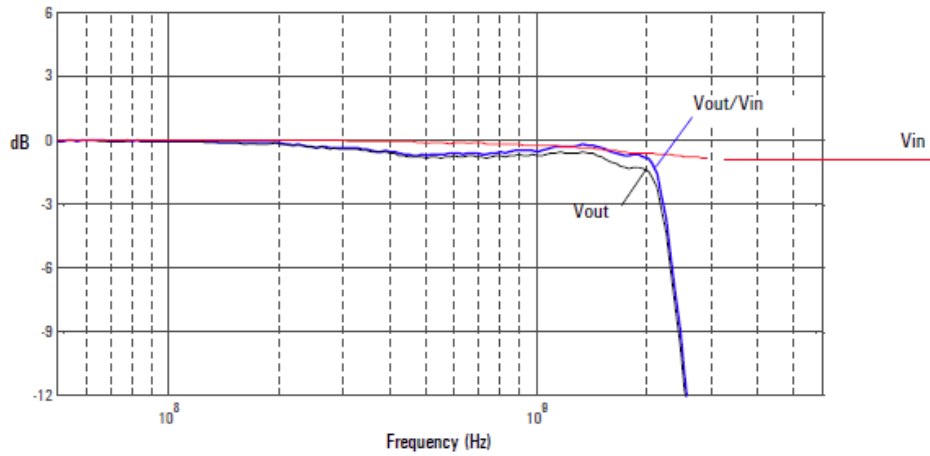


Figure 58 Graph of  $V_{in}$  and  $V_{out}$  of probe with a 25 ohm source and  $V_{out}/V_{in}$  frequency response.

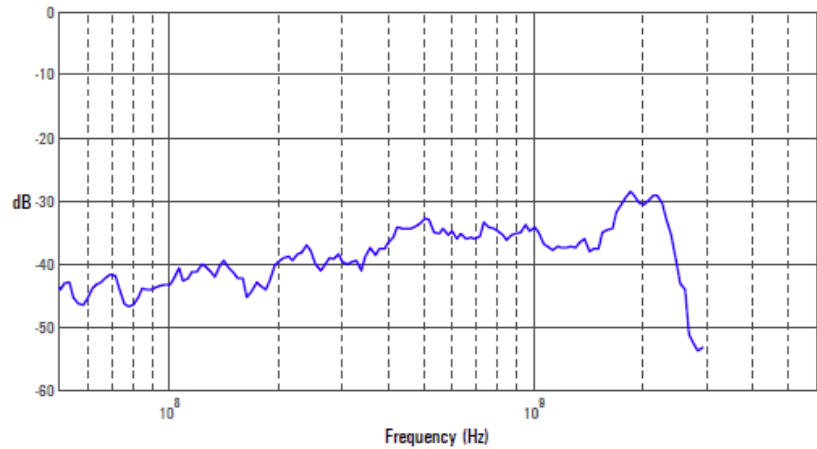
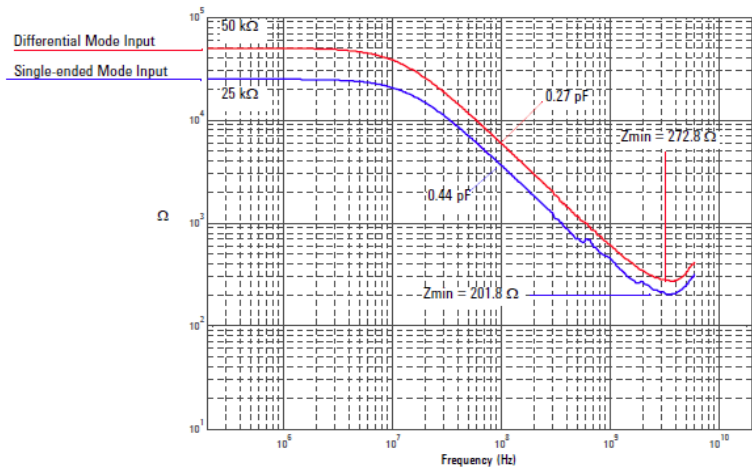


Figure 59 Graph of  $V_{out}/V_{in}$  frequency response when inputs driven in common (common mode rejection).

**5 1130A Performance Data Plots**  
E2677A Differential Solder-in Probe Head (Full BW)



**Figure 60** Magnitude plot of probe input impedance versus frequency.



## E2677A Differential Solder-in Probe Head (Medium BW)

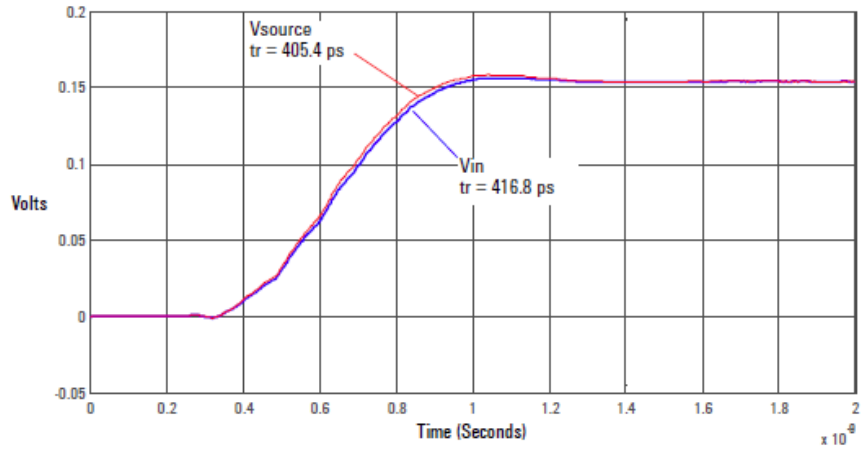


Figure 61 Graph of 25 ohm 405.4 ps step generator with and without probe connected.

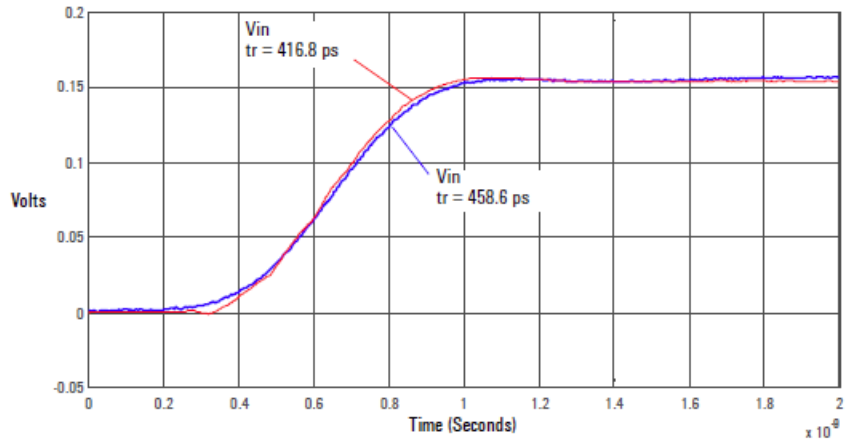
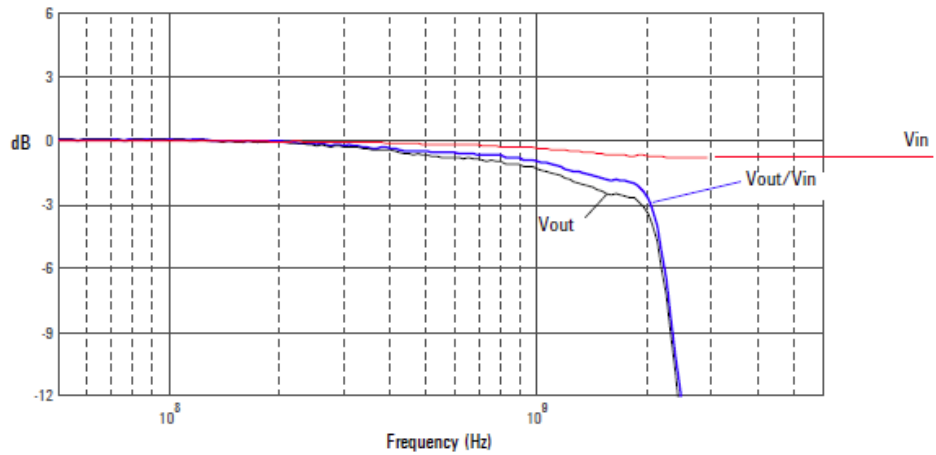
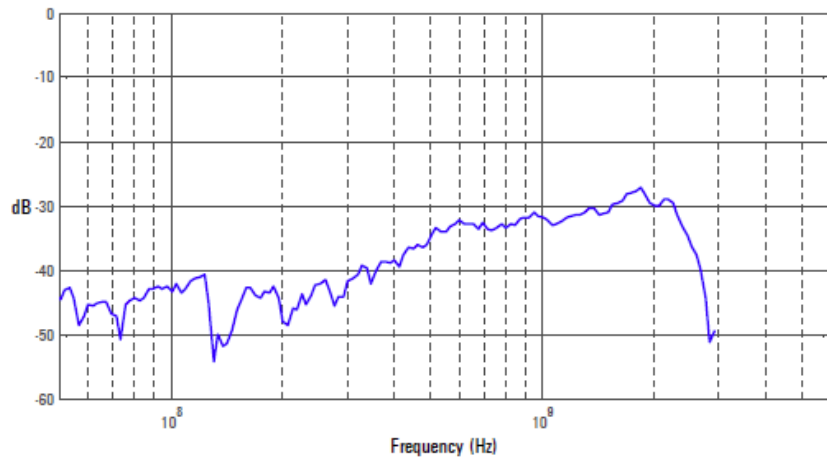


Figure 62 Graph of Vin and Vout of probe with a 25 ohm 405.4 ps step generator.

**5 1130A Performance Data Plots**  
E2677A Differential Solder-in Probe Head (Medium BW)



**Figure 63** Graph of  $V_{in}$  and  $V_{out}$  of probe with a 25 ohm source and  $V_{out}/V_{in}$  frequency response.



**Figure 64** Graph of  $V_{out}/V_{in}$  frequency response when inputs driven in common (common mode rejection).

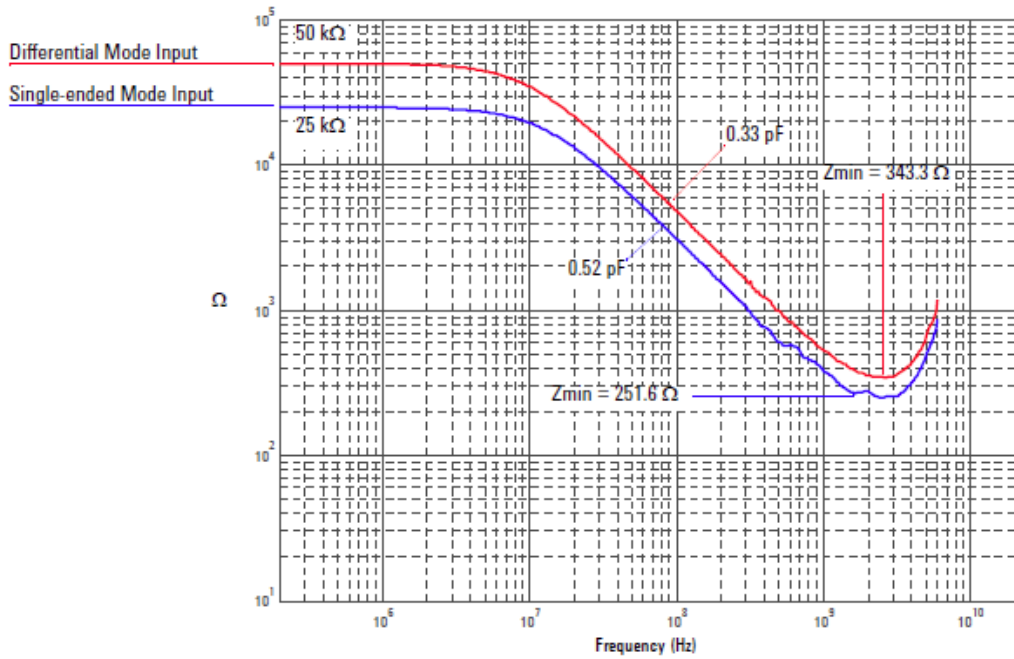


Figure 65 Magnitude plot of probe input impedance versus frequency.

## E2678A Differential Socketed Probe Head (Full BW)

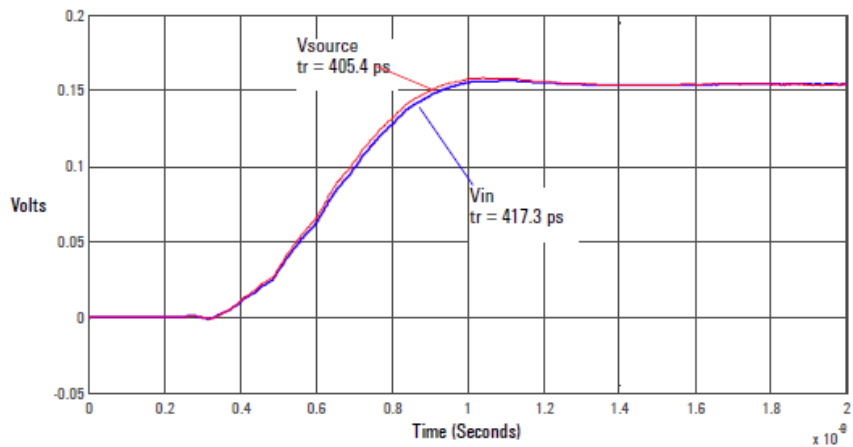


Figure 66 Graph of 25 ohm 405.4 ps step generator with and without probe connected.

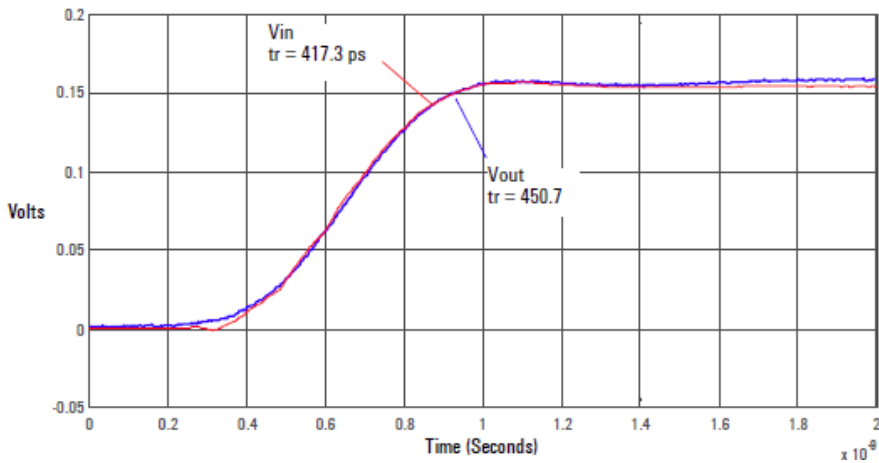


Figure 67 Graph of Vin and Vout of probe with a 25 ohm 405.4 ps step generator.

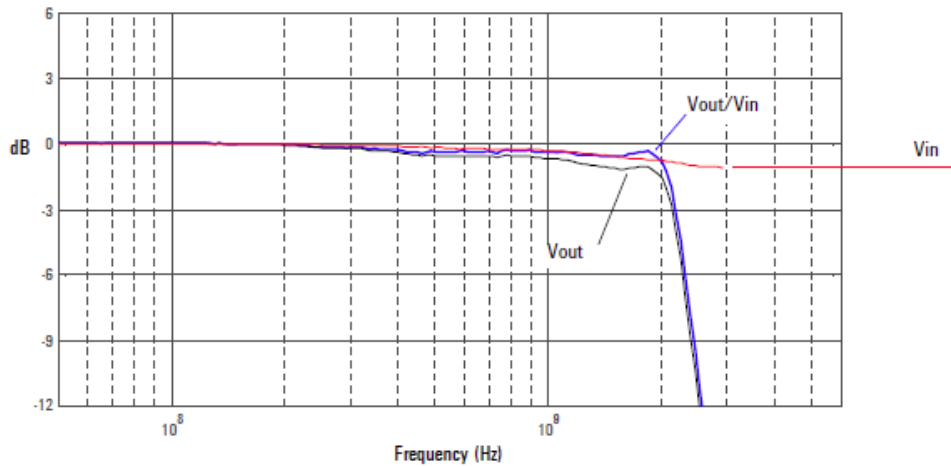


Figure 68 Graph of  $V_{in}$  and  $V_{out}$  of probe with a 25 ohm source and  $V_{out}/V_{in}$  frequency response.

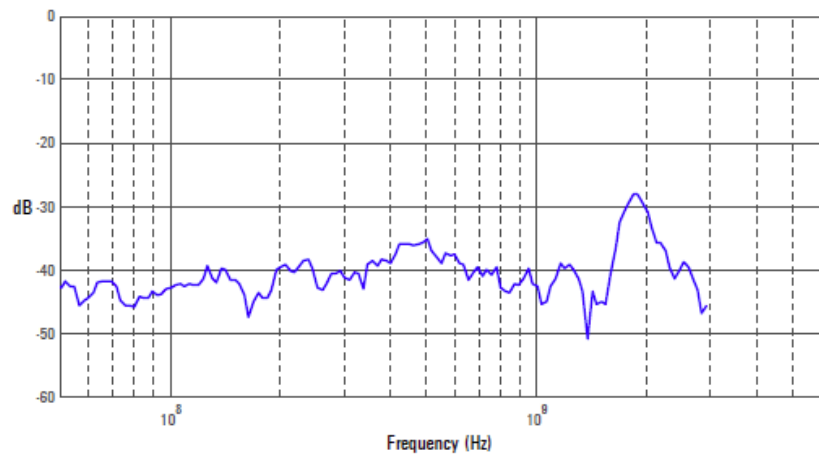
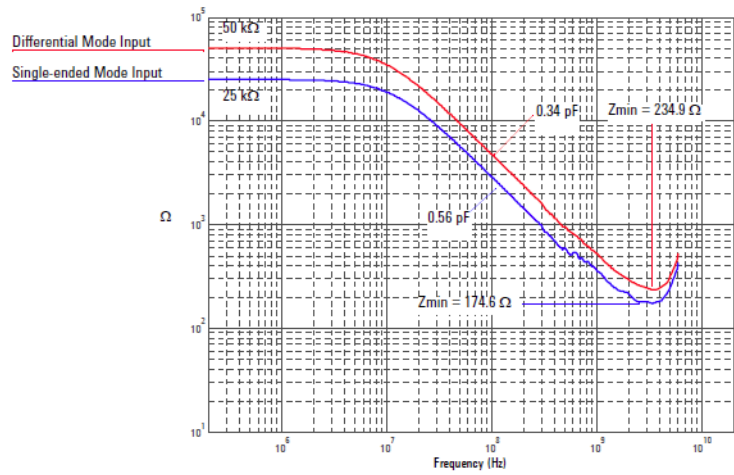


Figure 69 Graph of  $V_{out}/V_{in}$  frequency response when inputs driven in common (common mode rejection).

**5 1130A Performance Data Plots**  
E2678A Differential Socketed Probe Head (Full BW)



**Figure 70** Magnitude plot of probe input impedance versus frequency.

## E2678A Differential Socketed Probe Head with Damped Wire Accessory

### NOTE

Due to reflections on the long wire accessories, signals being probed should be limited to  $\geq 240$  ps rise time measured at the 10% and 90% amplitude levels. This is equivalent to  $\leq 4.5$  GHz bandwidth.

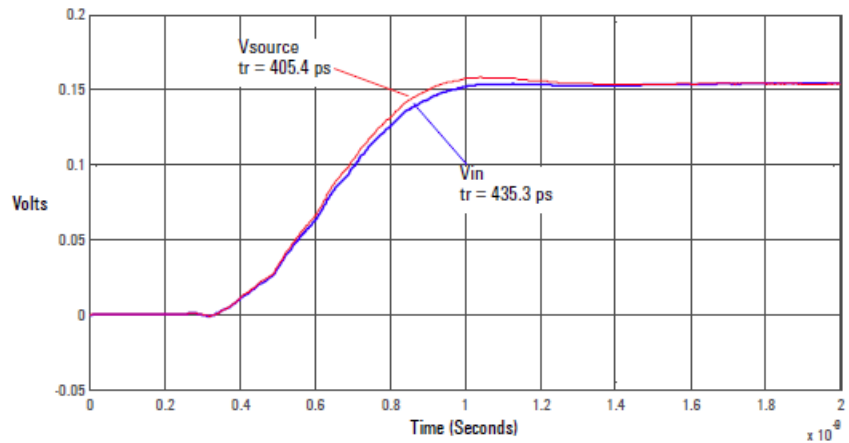
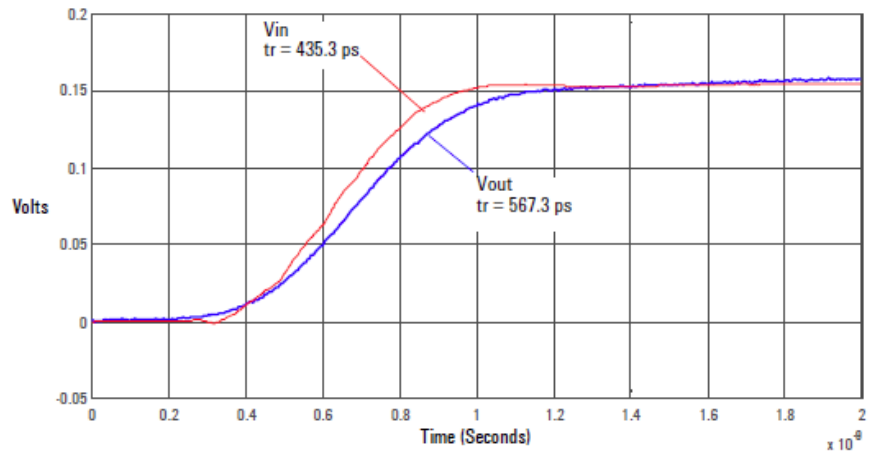
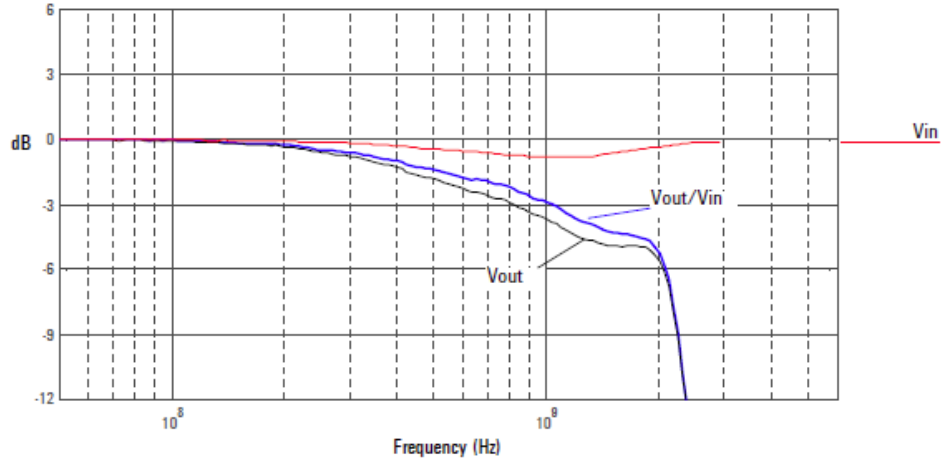


Figure 71 Graph of 25 ohm 240 ps step generator with and without probe connected.

**5 1130A Performance Data Plots**  
E2678A Differential Socketed Probe Head with Damped Wire Accessory



**Figure 72** Graph of  $V_{in}$  and  $V_{out}$  of probe with a 25 ohm 240 ps step generator.



**Figure 73** Graph of  $V_{in}$  and  $V_{out}$  of probe with a 25 ohm source and  $V_{out}/V_{in}$  frequency response.



E2678A Differential Socketed Probe Head with Damped Wire Accessory

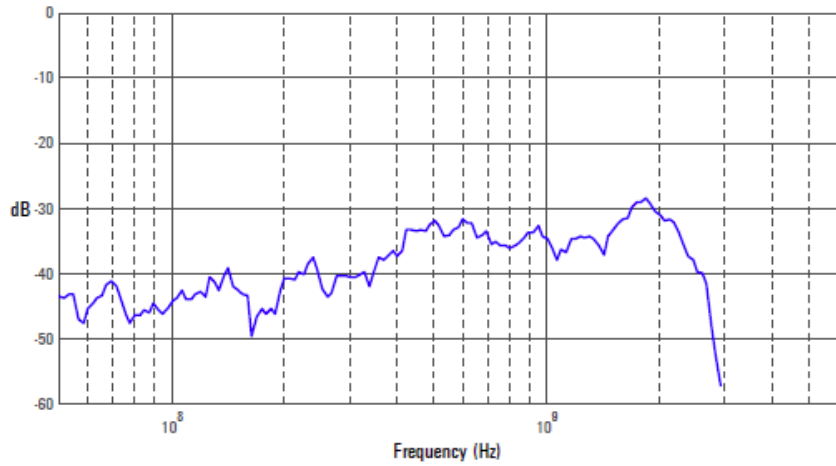
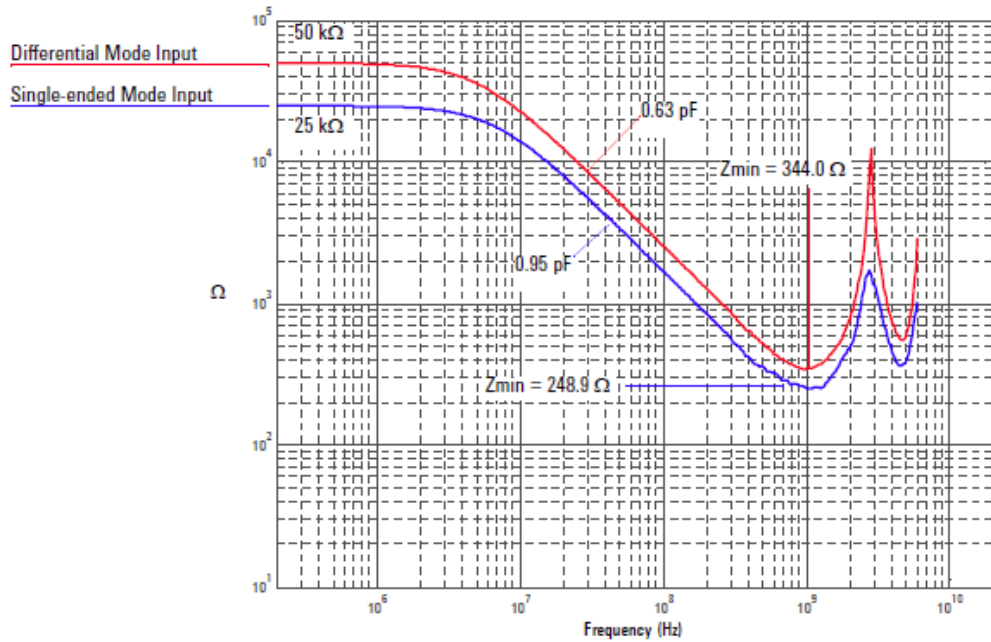


Figure 74 Graph of Vout/Vin frequency response when inputs driven in common (common mode rejection).

**5 1130A Performance Data Plots**  
E2678A Differential Socketed Probe Head with Damped Wire Accessory



**Figure 75** Magnitude plot of probe input impedance versus frequency.

## E2679A Single-Ended Solder-in Probe Head (Full BW)

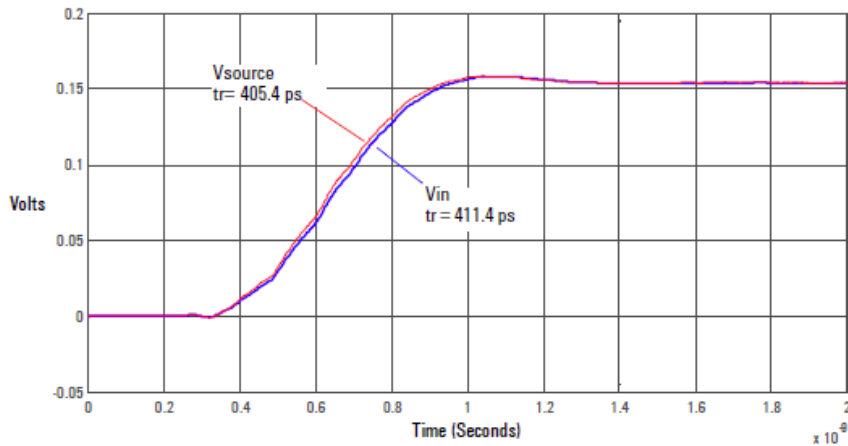


Figure 76 Graph of 25 ohm 405.4 ps step generator with and without probe connected.

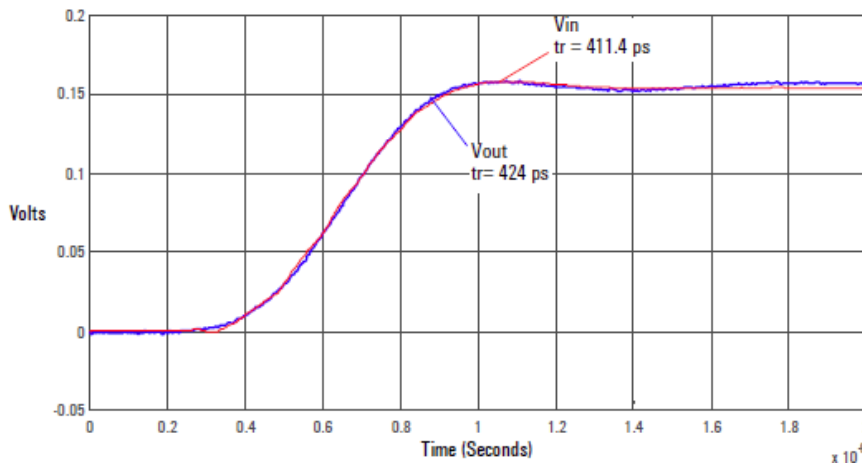
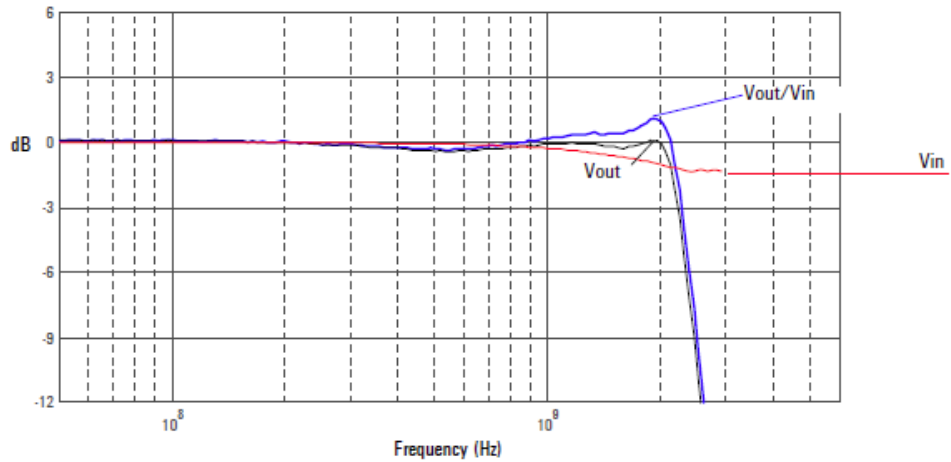
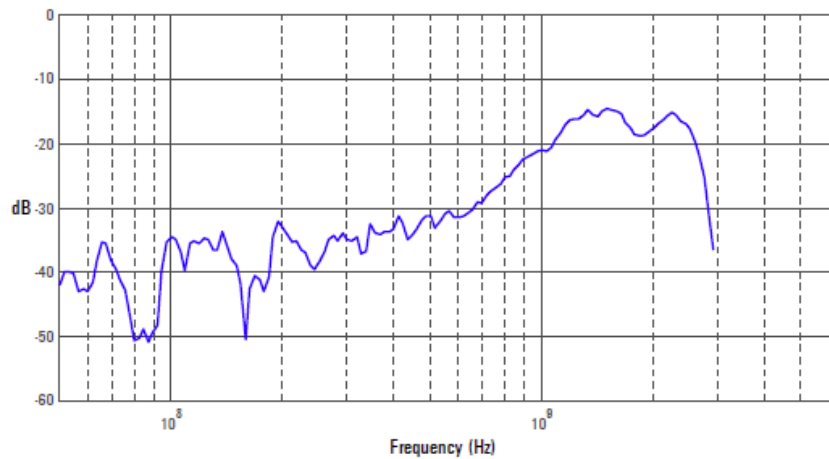


Figure 77 Graph of  $V_{in}$  and  $V_{out}$  of probe with a 25 ohm 405.4 ps step generator.

**5 1130A Performance Data Plots**  
E2679A Single-Ended Solder-in Probe Head (Full BW)



**Figure 78** Graph of  $V_{in}$  and  $V_{out}$  of probe with a 25 ohm source and  $V_{out}/V_{in}$  frequency response.



**Figure 79** Graph of  $V_{out}/V_{in}$  frequency response when inputs driven in common (common mode rejection).

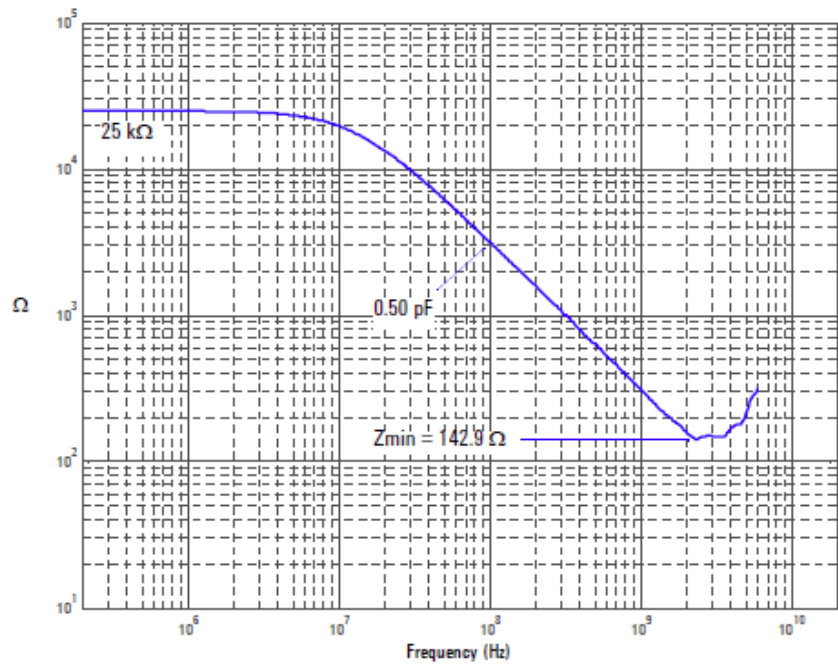


Figure 80 Magnitude plot of probe input impedance versus frequency.

## E2679A Single-Ended Solder-in Probe Head (Medium BW)

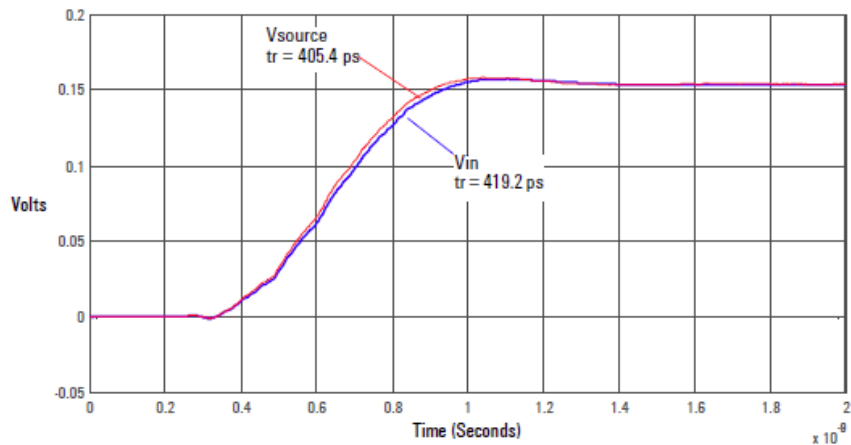


Figure 81 Graph of 25 ohm 405.4 ps step generator with and without probe connected.

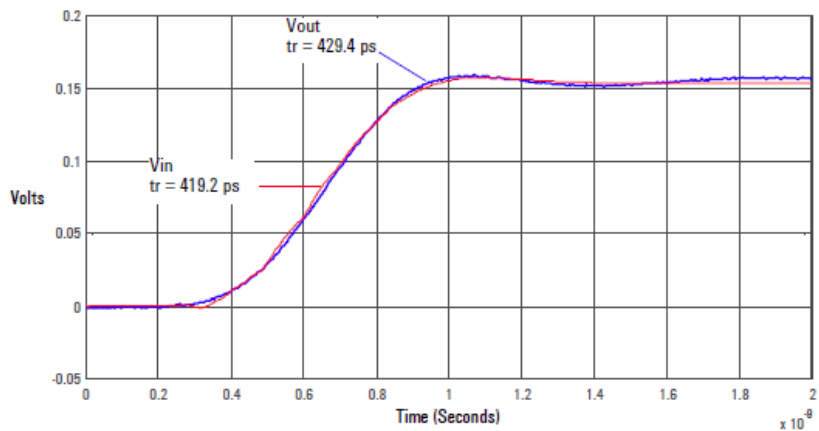


Figure 82 Graph of  $V_{in}$  and  $V_{out}$  of probe with a 25 ohm 405.4 ps step generator.

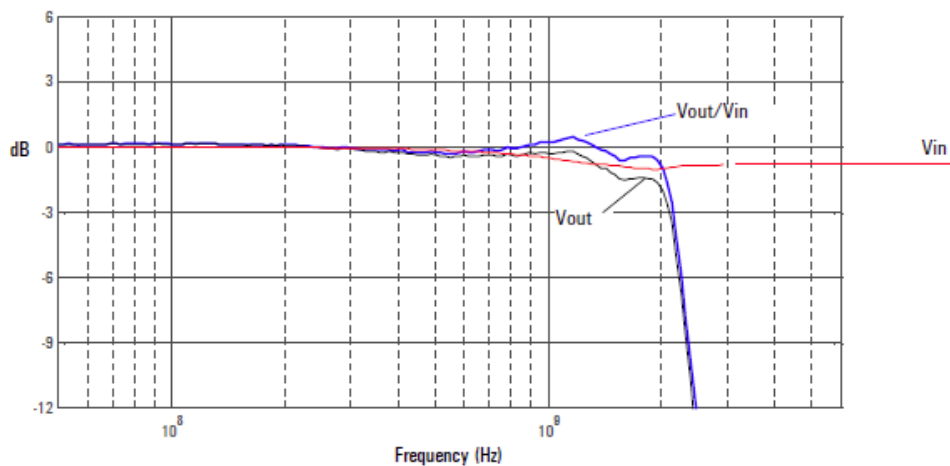


Figure 83 Graph of Vin and Vout of probe with a 25 ohm source and Vout/Vin frequency response.

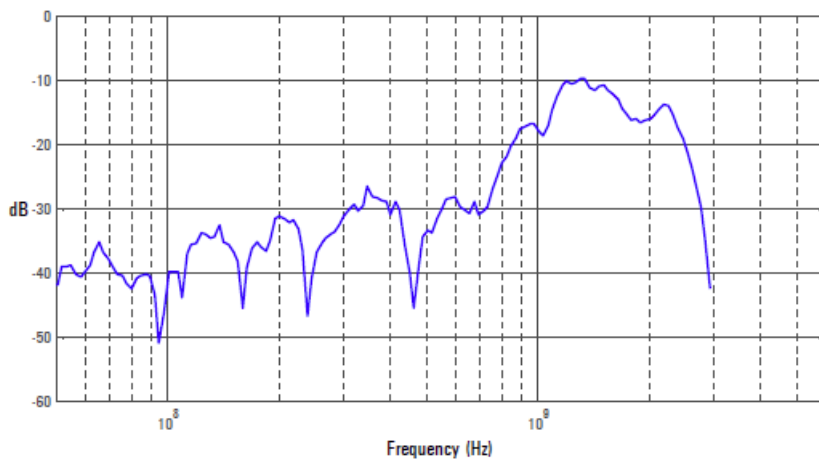
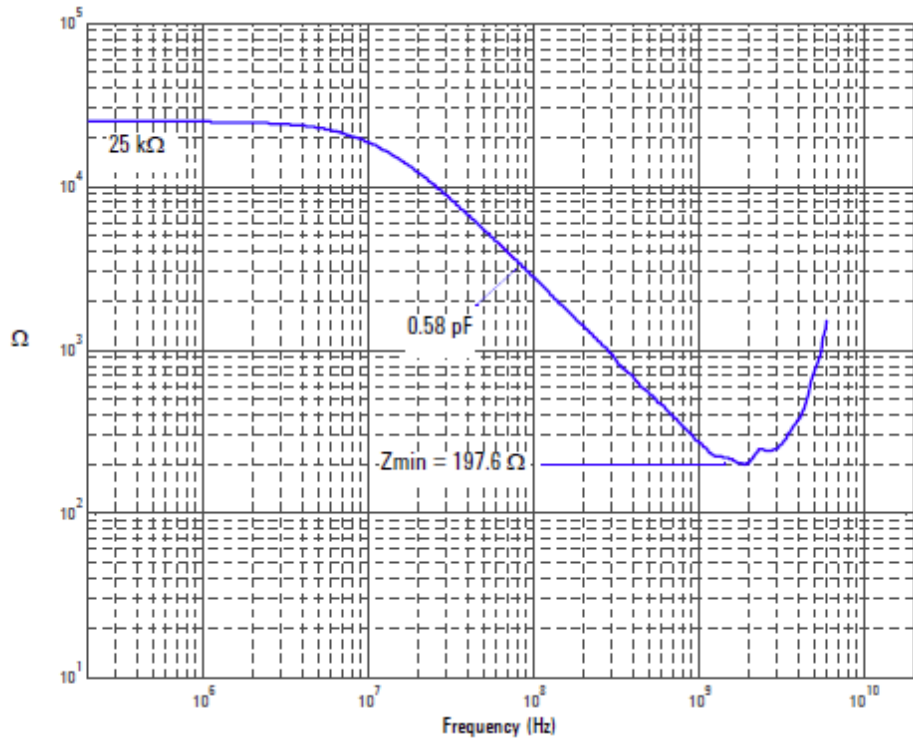


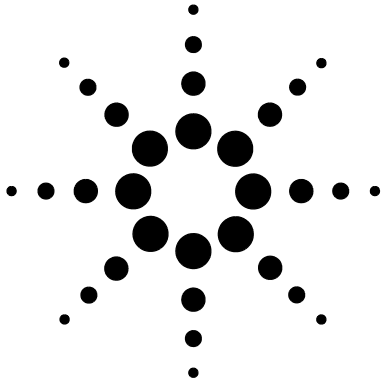
Figure 84 Graph of Vout/Vin frequency response when inputs driven in common (common mode rejection).

**5 1130A Performance Data Plots**  
E2679A Single-Ended Solder-in Probe Head (Medium BW)



**Figure 85** Magnitude plot of probe input impedance versus frequency.





## 6

# 1131A Performance Data Plots

|  |     |
|--|-----|
| E2675A Differential Browser  | 122 |
| E2676A Single-Ended Browser  | 125 |
| E2677A Differential Solder-in Probe Head (Full BW)                 | 128 |
| E2677A Differential Solder-in Probe Head (Medium BW)               | 131 |
| E2678A Differential Socketed Probe Head (Full BW)                  | 134 |
| E2678A Differential Socketed Probe Head with Damped Wire Accessory | 137 |
| E2679A Single-Ended Solder-in Probe Head (Full BW)                 | 141 |
| E2679A Single-Ended Solder-in Probe Head (Medium BW)               | 144 |

This chapter provides graphs of the performance characteristics of the 1131A probes using the different probe heads that come with the E2668A single-ended and E2669A differential connectivity kits.

---

### NOTE

---

All rise times shown are measured from the 10% to the 90% amplitude levels.

## E2675A Differential Browser

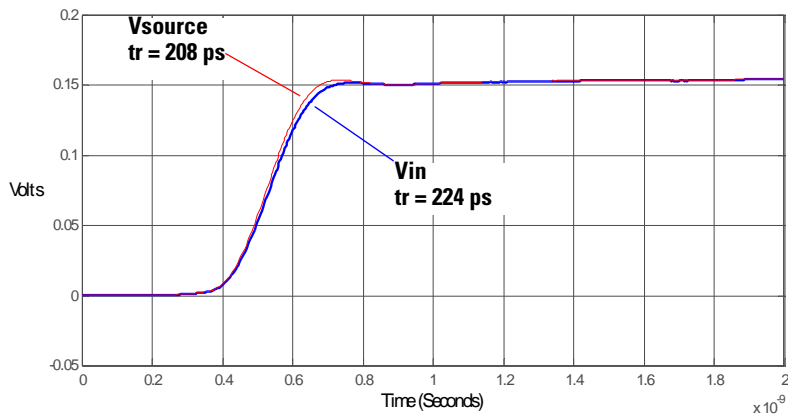


Figure 86 Graph of 25Ω 200 ps step generator with and without probe connected.

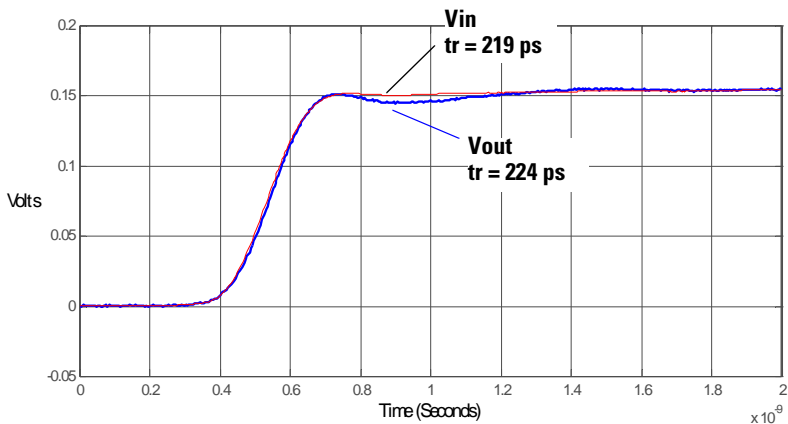


Figure 87 Graph of Vin and Vout of probe with a 25Ω 200 ps step generator.

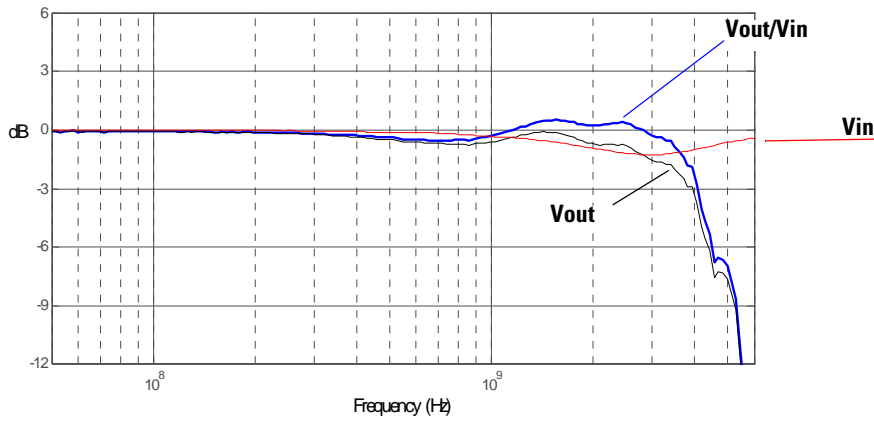


Figure 88 Graph of  $V_{in}$  and  $V_{out}$  of probe with a  $25\Omega$  source and  $V_{out}/V_{in}$  frequency response.

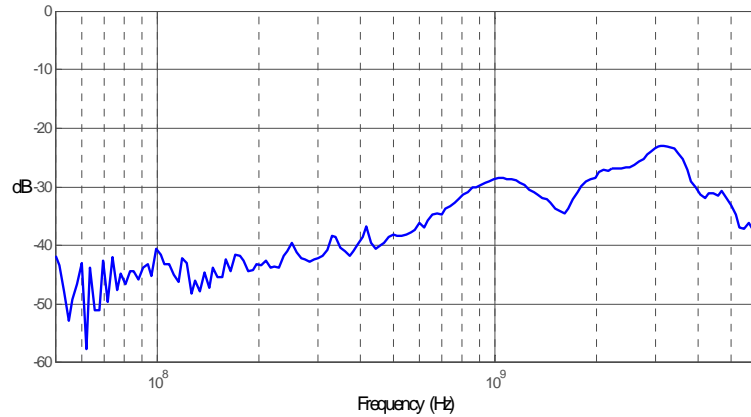
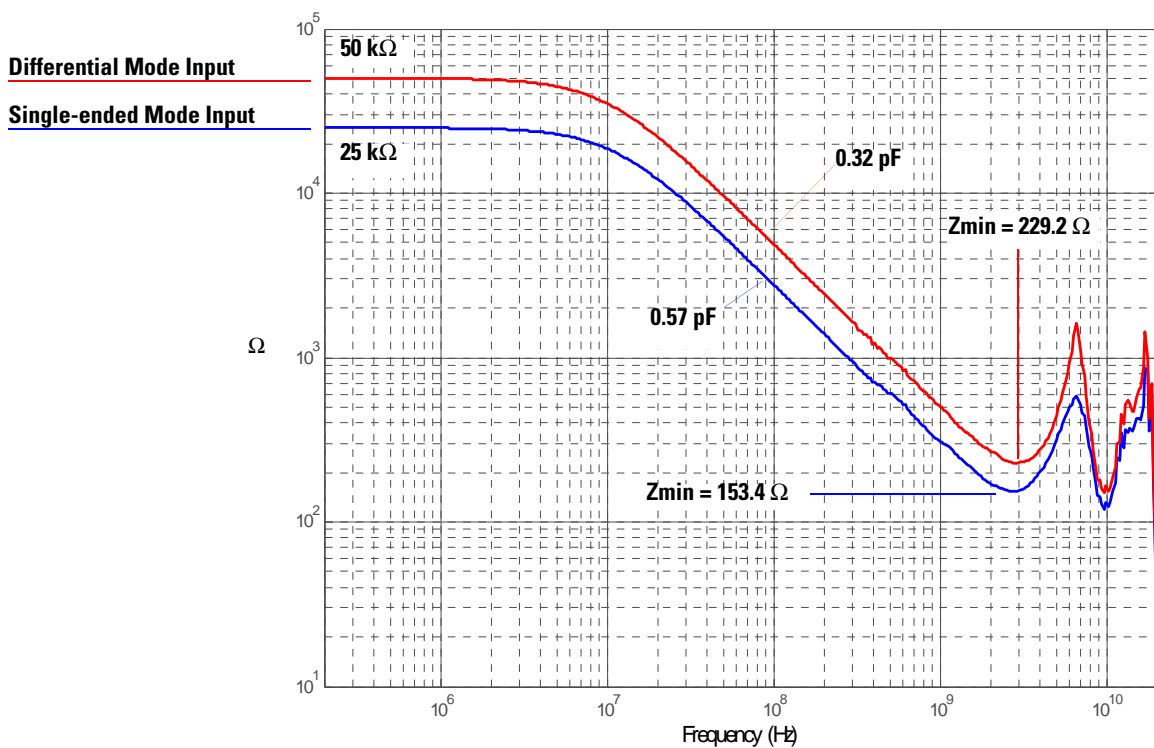


Figure 89 Graph of  $V_{out}/V_{in}$  frequency response when inputs driven in common (common mode rejection).

**6 1131A Performance Data Plots**  
E2675A Differential Browser



**Figure 90** Magnitude plot of probe input impedance versus frequency.

## E2676A Single-Ended Browser

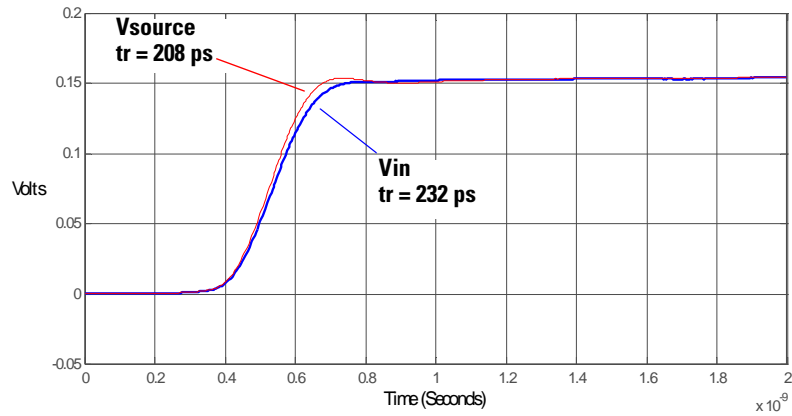


Figure 91 Graph of 25Ω 200 ps step generator with and without probe connected.

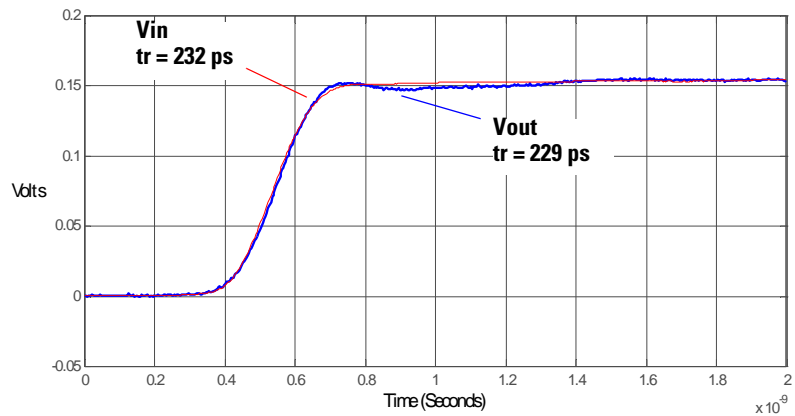
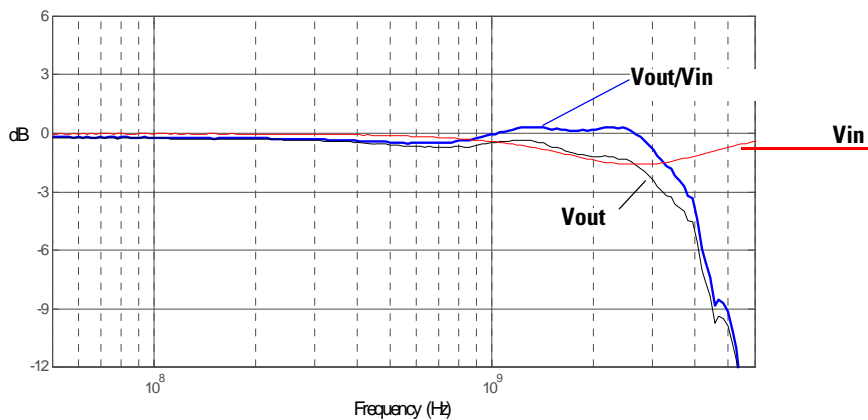
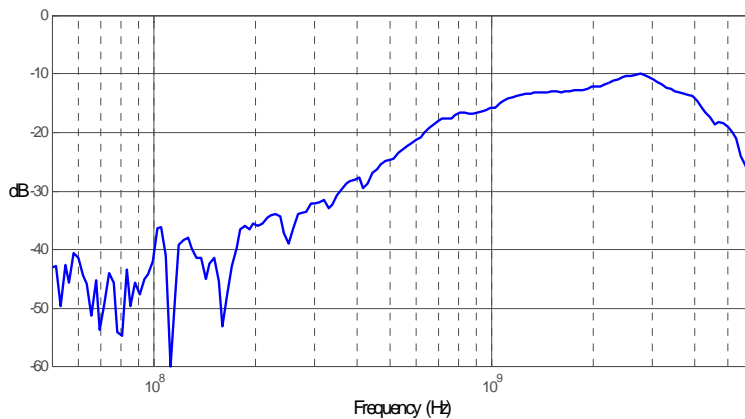


Figure 92 Graph of Vin and Vout of probe with a 25Ω 200 ps step generator.

**6 1131A Performance Data Plots**  
E2676A Single-Ended Browser



**Figure 93** Graph of  $V_{in}$  and  $V_{out}$  of probe with a  $25\Omega$  source and  $V_{out}/V_{in}$  frequency response.



**Figure 94** Graph of  $V_{out}/V_{in}$  frequency response when inputs driven in common (common mode rejection).

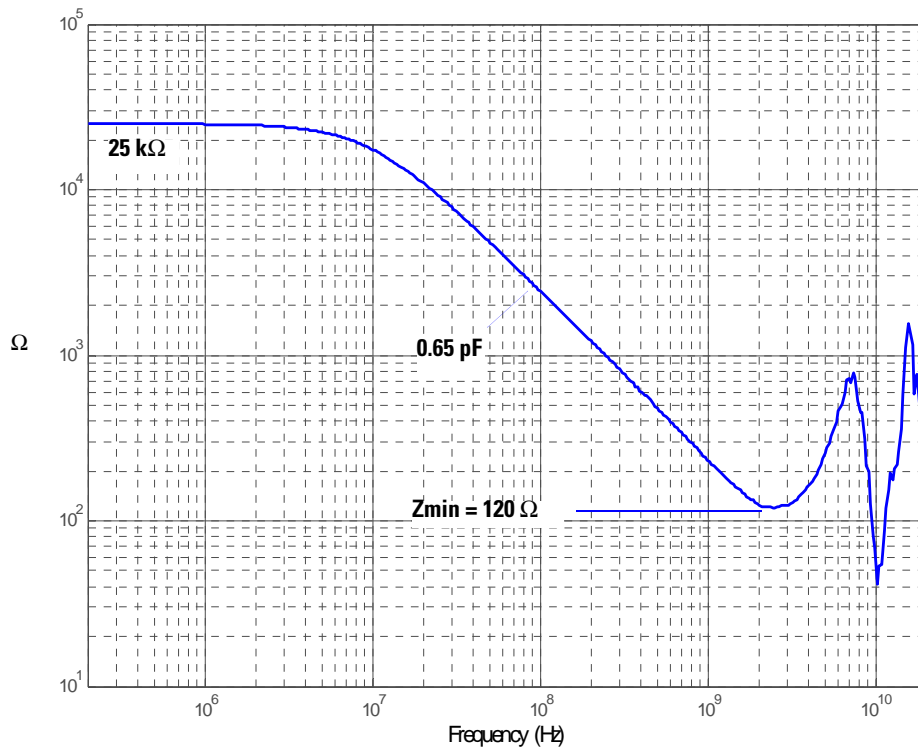


Figure 95 Magnitude plot of probe input impedance versus frequency.

## E2677A Differential Solder-in Probe Head (Full BW)

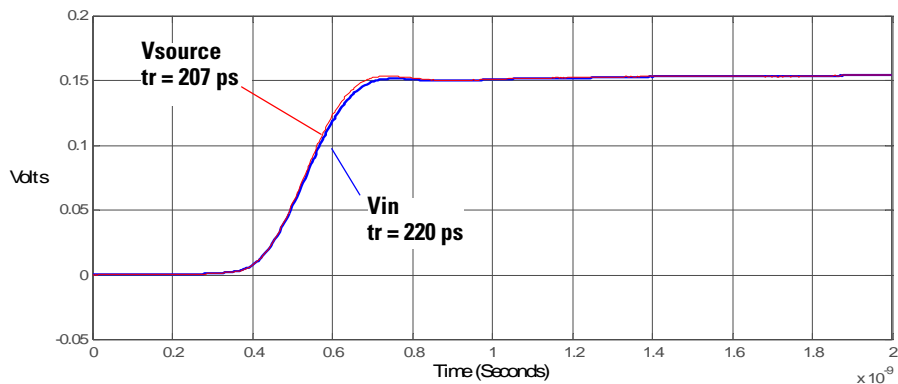


Figure 96 Graph of 25 ohm 200 ps step generator with and without probe connected.

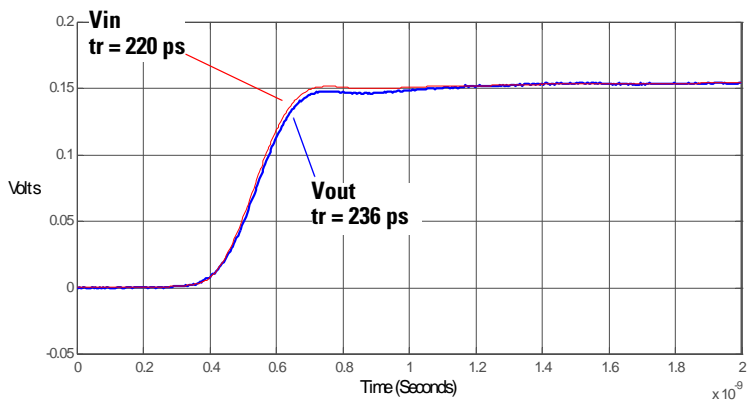


Figure 97 Graph of  $V_{in}$  and  $V_{out}$  of probe with a 25 ohm 200 ps step generator.



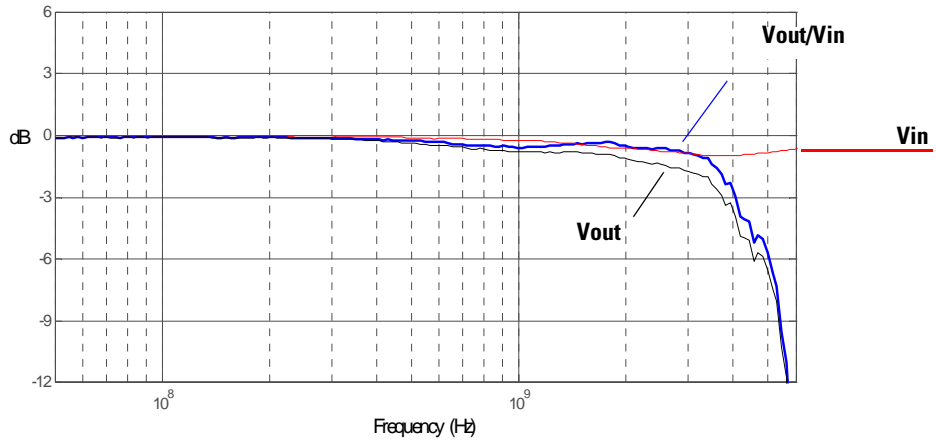


Figure 98 Graph of  $V_{in}$  and  $V_{out}$  of probe with a 25 ohm source and  $V_{out}/V_{in}$  frequency response.

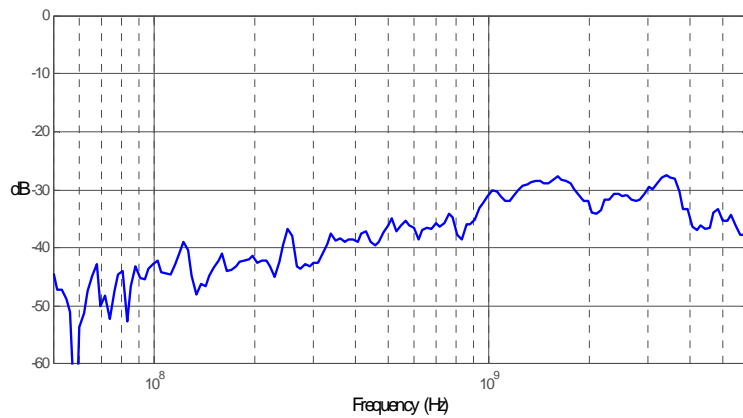
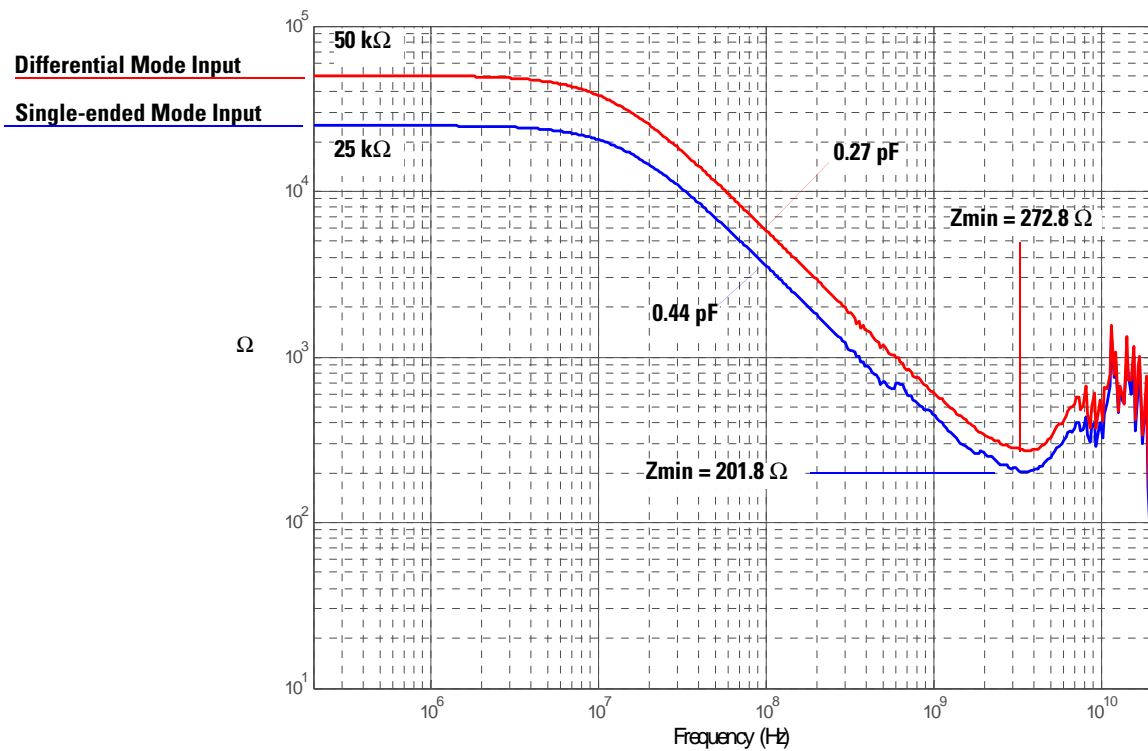


Figure 99 Graph of  $V_{out}/V_{in}$  frequency response when inputs driven in common (common mode rejection).

**6 1131A Performance Data Plots**  
E2677A Differential Solder-in Probe Head (Full BW)



**Figure 100** Magnitude plot of probe input impedance versus frequency.

## E2677A Differential Solder-in Probe Head (Medium BW)

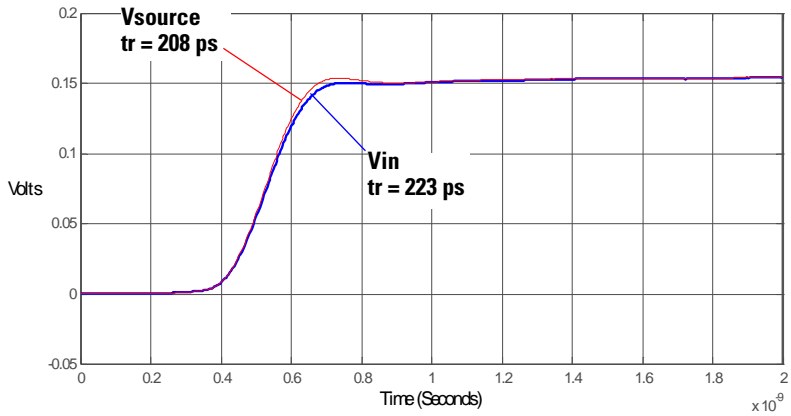


Figure 101 Graph of 25Ω 200 ps step generator with and without probe connected.

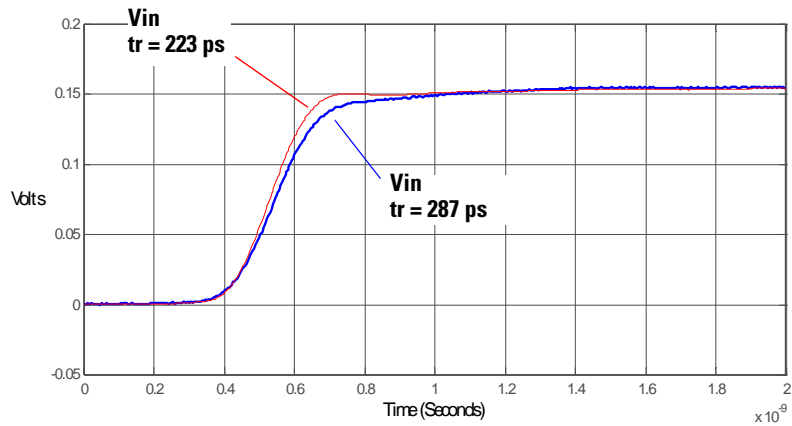
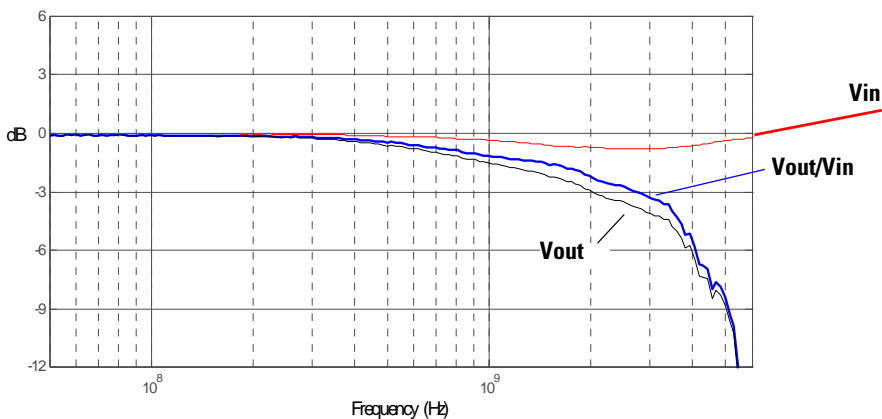
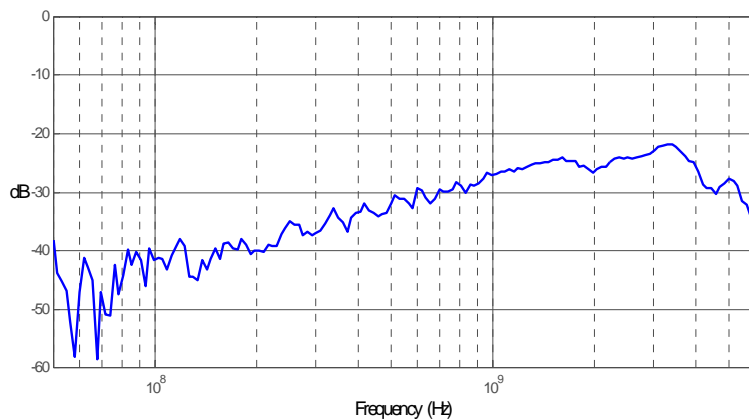


Figure 102 Graph of V<sub>in</sub> and V<sub>out</sub> of probe with a 25Ω 200 ps step generator.

**6 1131A Performance Data Plots**  
E2677A Differential Solder-in Probe Head (Medium BW)



**Figure 103** Graph of  $V_{in}$  and  $V_{out}$  of probe with a  $25\Omega$  source and  $V_{out}/V_{in}$  frequency response.



**Figure 104** Graph of  $V_{out}/V_{in}$  frequency response when inputs driven in common (common mode rejection).

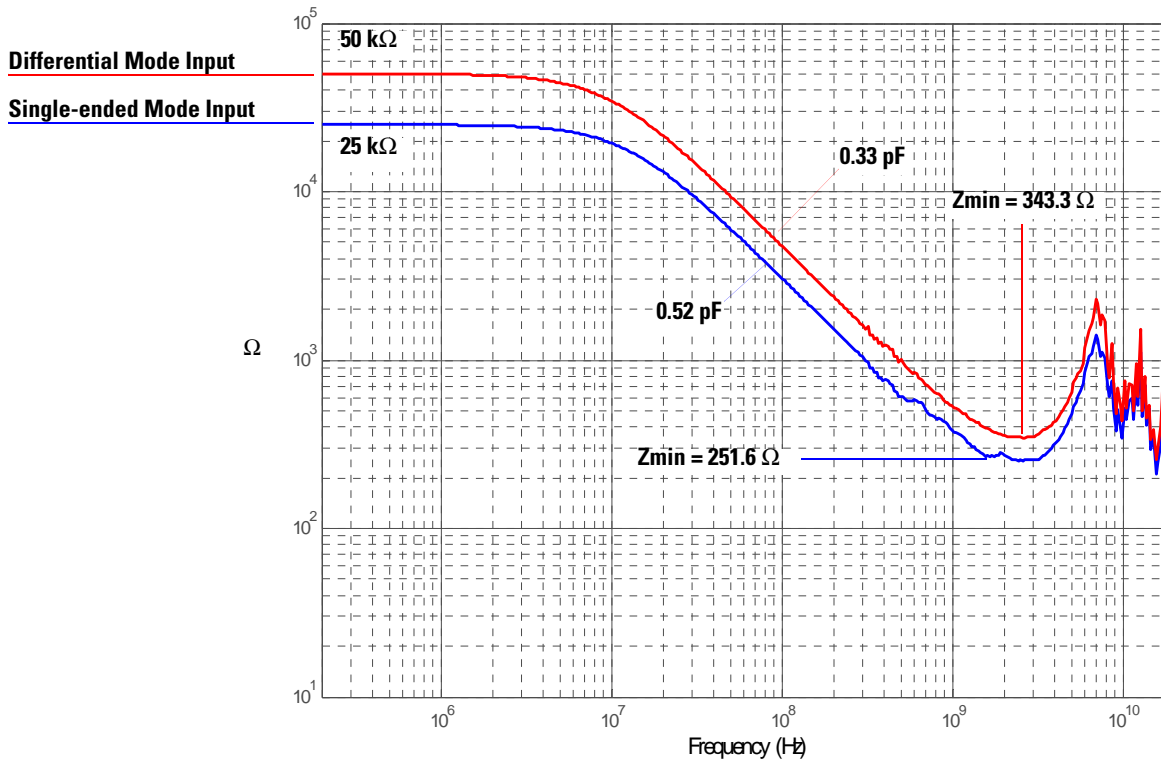


Figure 105 Magnitude plot of probe input impedance versus frequency.

## E2678A Differential Socketed Probe Head (Full BW)

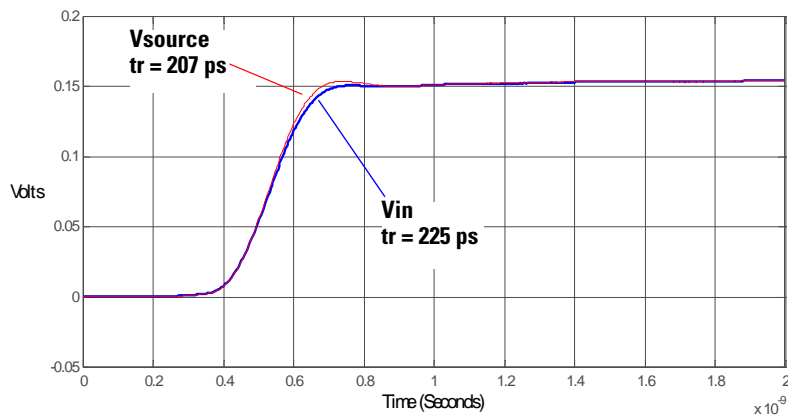


Figure 106 Graph of 25Ω 200 ps step generator with and without probe connected.

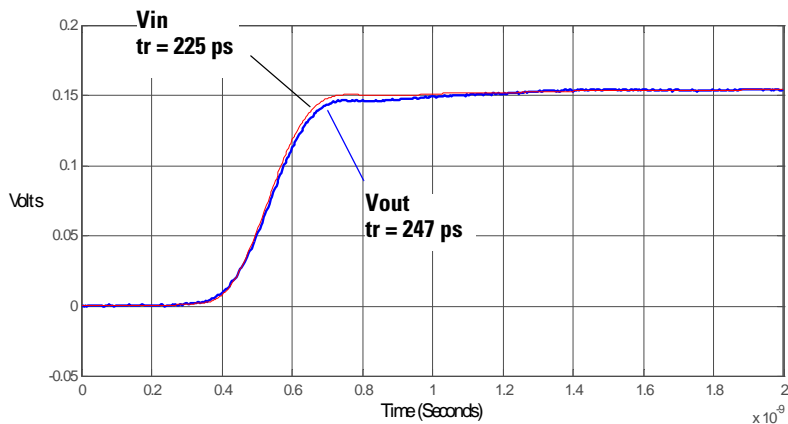


Figure 107 Graph of Vin and Vout of probe with a 25Ω 200 ps step generator.

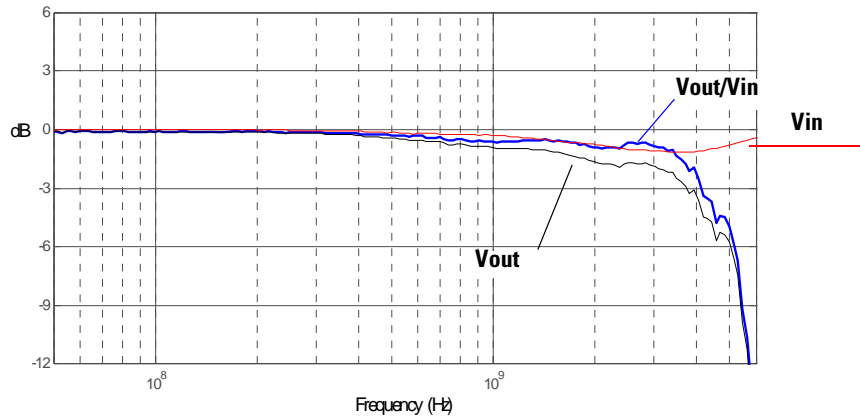


Figure 108 Graph of  $V_{in}$  and  $V_{out}$  of probe with a  $25\Omega$  source and  $V_{out}/V_{in}$  frequency response.

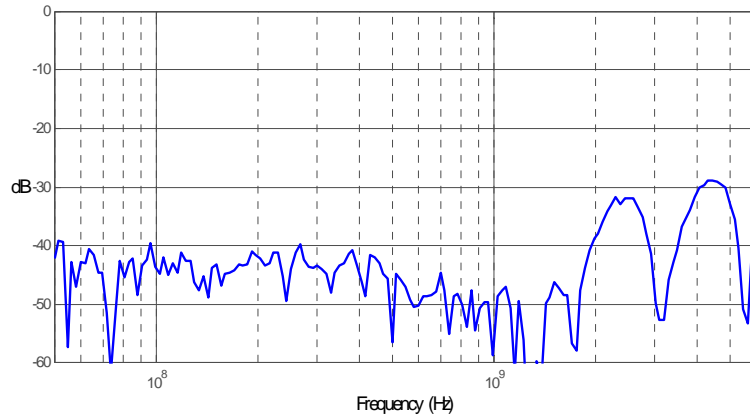
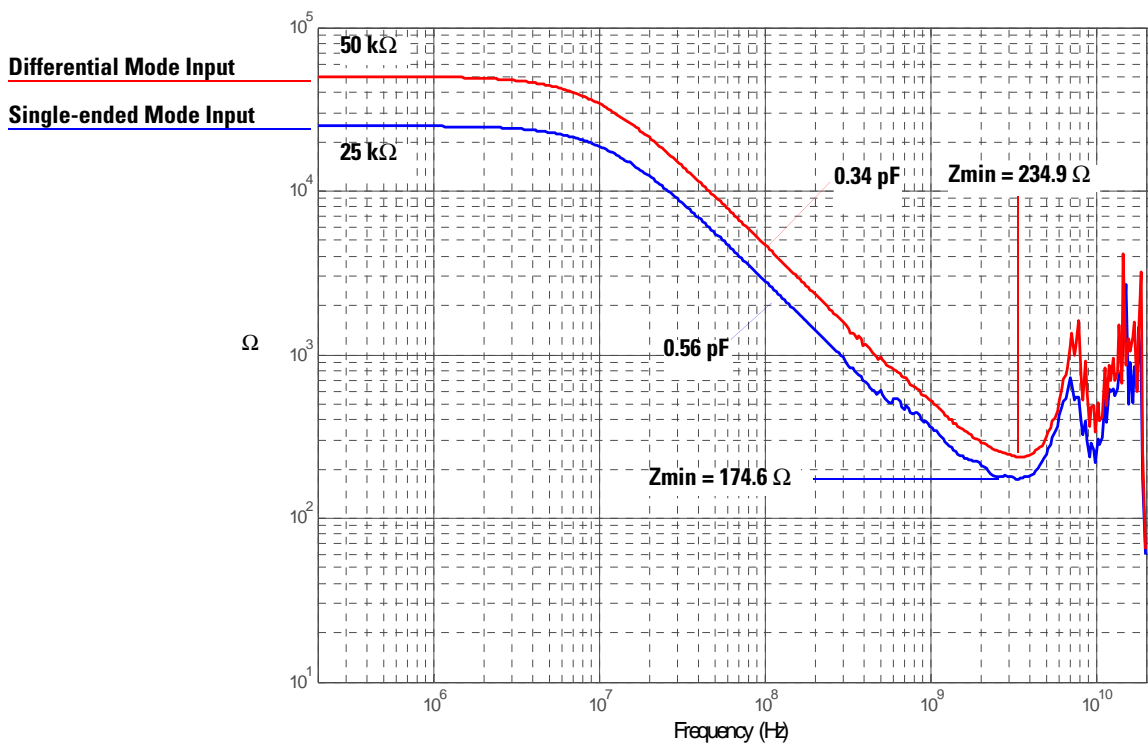


Figure 109 Graph of  $V_{out}/V_{in}$  frequency response when inputs driven in common (common mode rejection).

**6 1131A Performance Data Plots**  
E2678A Differential Socketed Probe Head (Full BW)



**Figure 110 Magnitude plot of probe input impedance versus frequency.**



## E2678A Differential Socketed Probe Head with Damped Wire Accessory

### NOTE

Due to reflections on the long wire accessories, signals being probed should be limited to  $\geq 240$  ps rise time measured at the 10% and 90% amplitude levels. This is equivalent to  $\leq 1.5$  GHz bandwidth.

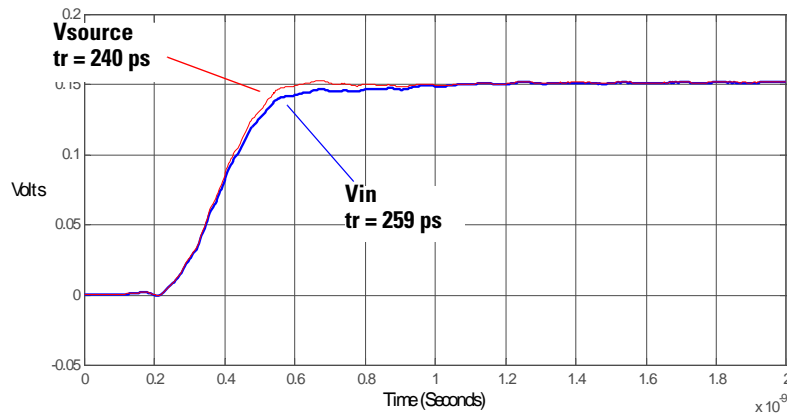
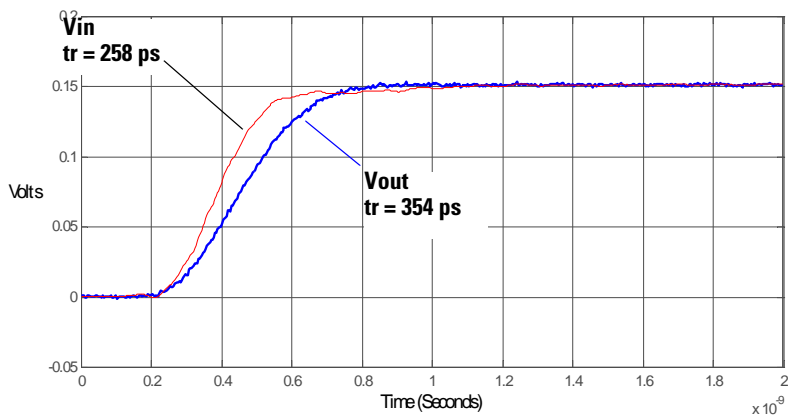
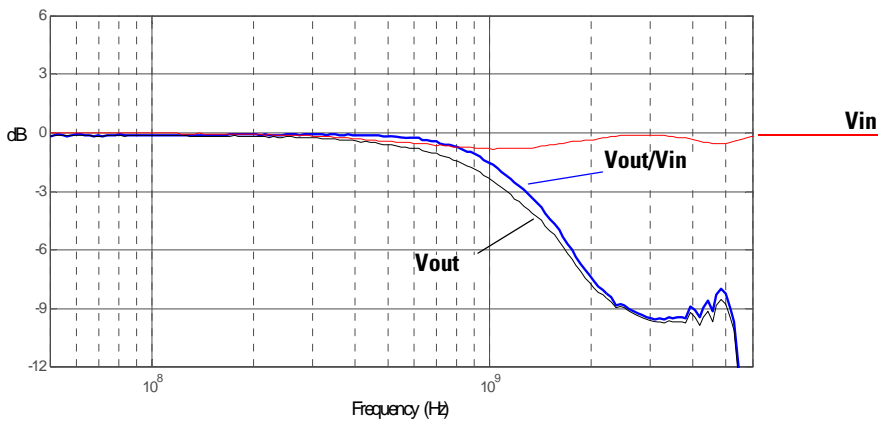


Figure 111 Graph of  $25\Omega$  240 ps step generator with and without probe connected.

**6 1131A Performance Data Plots**  
E2678A Differential Socketed Probe Head with Damped Wire Accessory

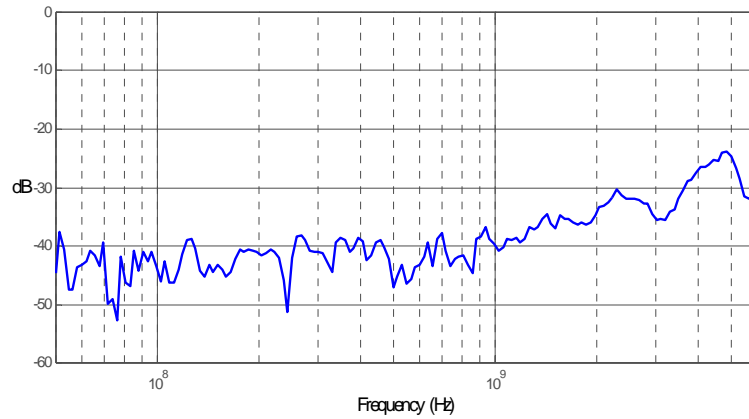


**Figure 112** Graph of  $V_{in}$  and  $V_{out}$  of probe with a  $25\Omega$  240 ps step generator.



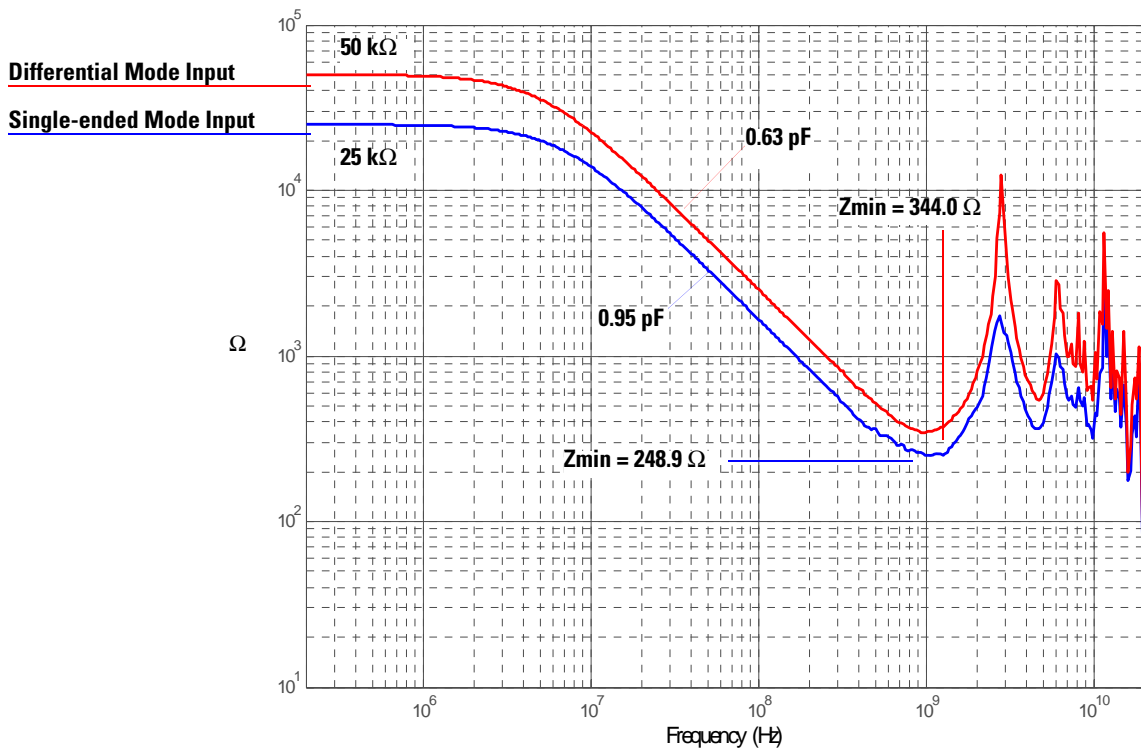
**Figure 113** Graph of  $V_{in}$  and  $V_{out}$  of probe with a  $25\Omega$  source and  $V_{out}/V_{in}$  frequency response.

## E2678A Differential Socketed Probe Head with Damped Wire Accessory



**Figure 114** Graph of  $V_{out}/V_{in}$  frequency response when inputs driven in common (common mode rejection).

**6 1131A Performance Data Plots**  
E2678A Differential Socketed Probe Head with Damped Wire Accessory



**Figure 115** Magnitude plot of probe input impedance versus frequency.

## E2679A Single-Ended Solder-in Probe Head (Full BW)

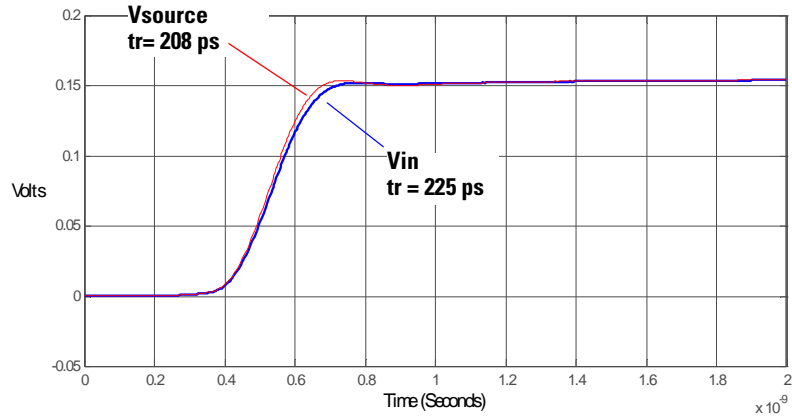


Figure 116 Graph of 25Ω 200 ps step generator with and without probe connected.

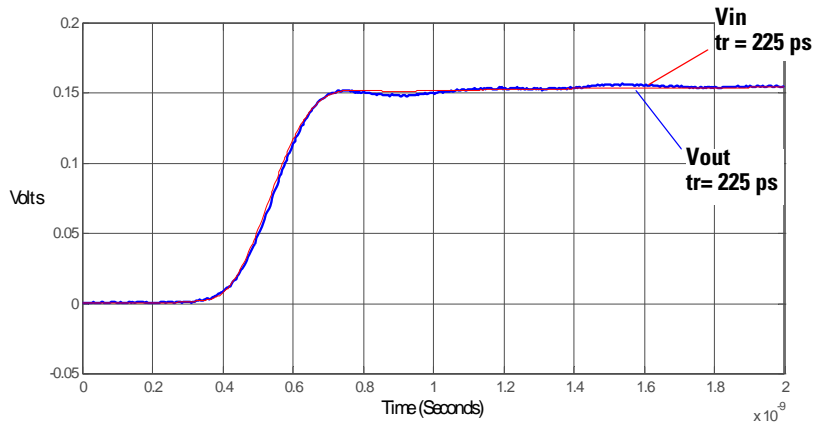
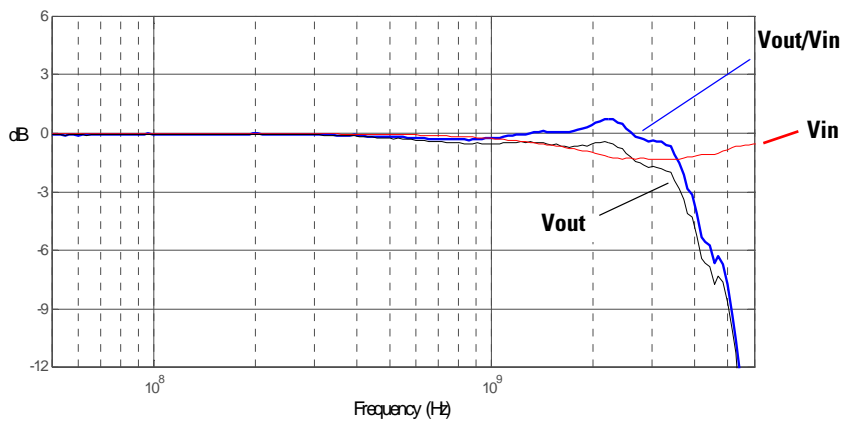
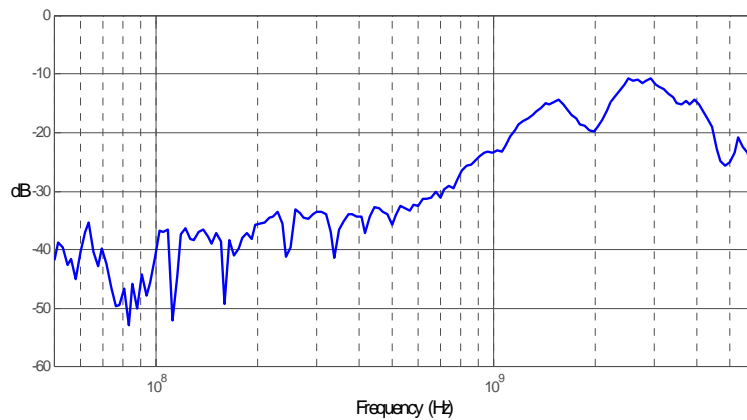


Figure 117 Graph of Vin and Vout of probe with a 25Ω 200 ps step generator.

**6 1131A Performance Data Plots**  
E2679A Single-Ended Solder-in Probe Head (Full BW)



**Figure 118** Graph of  $V_{in}$  and  $V_{out}$  of probe with a  $25\Omega$  source and  $V_{out}/V_{in}$  frequency response.



**Figure 119** Graph of  $V_{out}/V_{in}$  frequency response when inputs driven in common (common mode rejection).

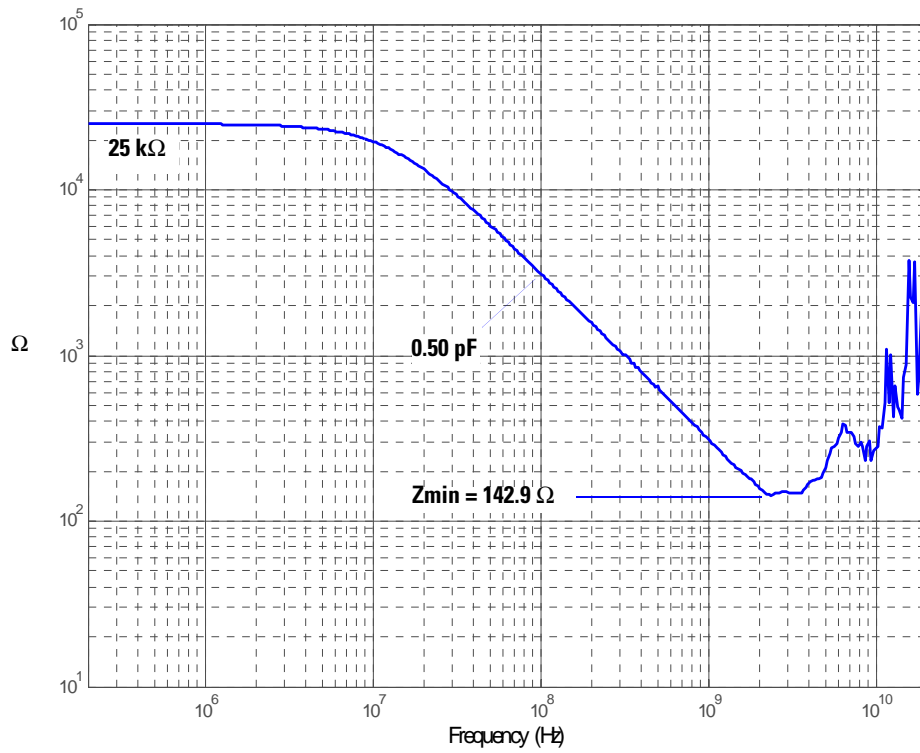


Figure 120 Magnitude plot of probe input impedance versus frequency.

## E2679A Single-Ended Solder-in Probe Head (Medium BW)

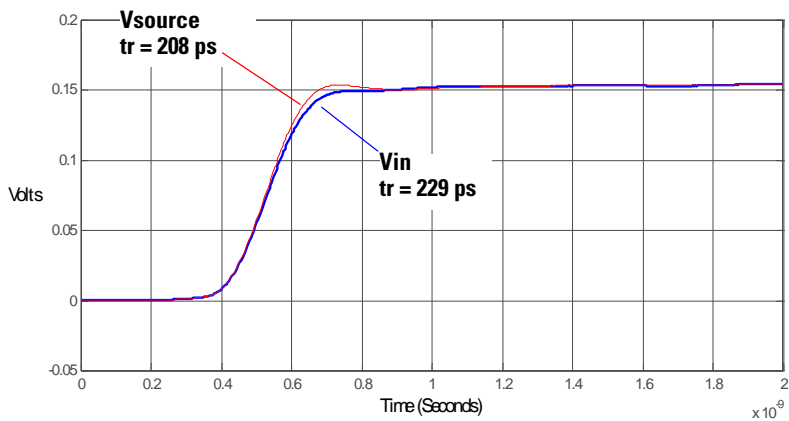


Figure 121 Graph of 25Ω 200 ps step generator with and without probe connected.

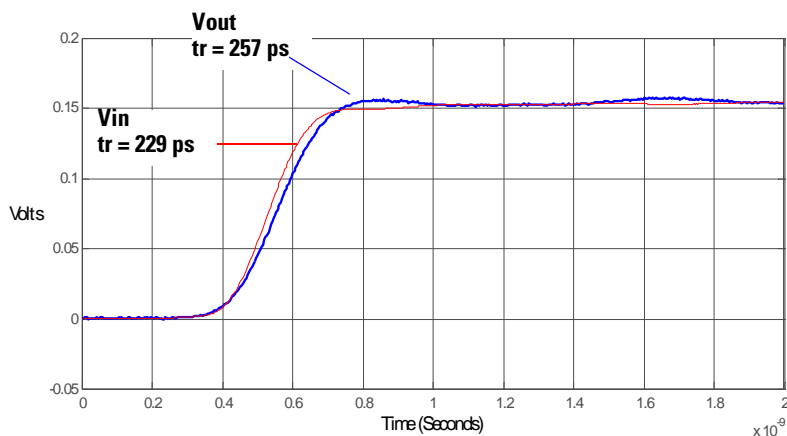


Figure 122 Graph of Vin and Vout of probe with a 25Ω 200 ps step generator.



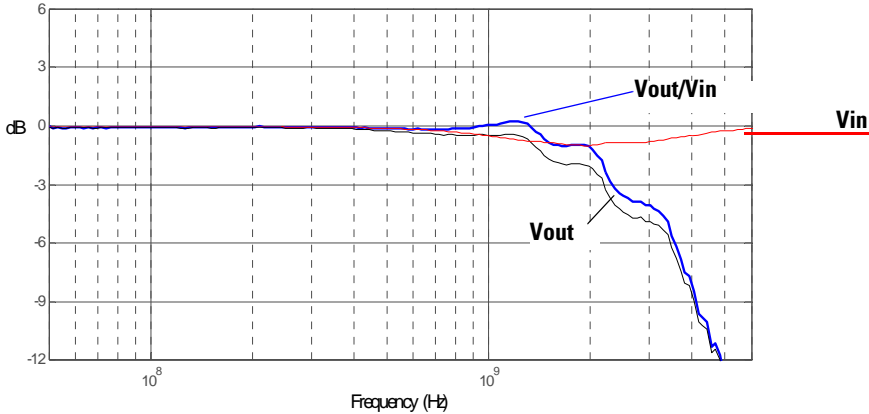


Figure 123 Graph of Vin and Vout of probe with a 25Ω source and Vout/Vin frequency response.

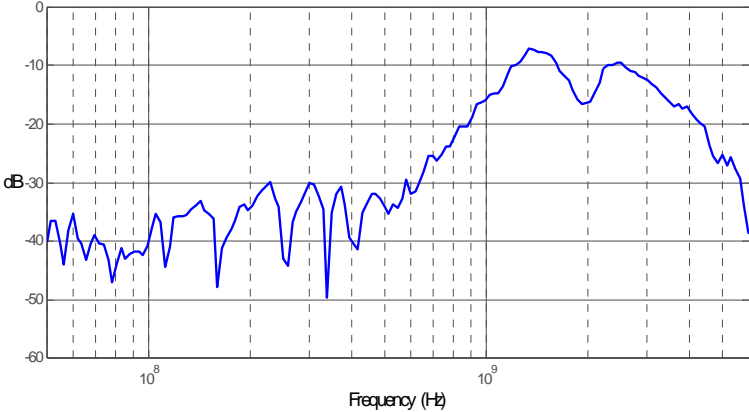
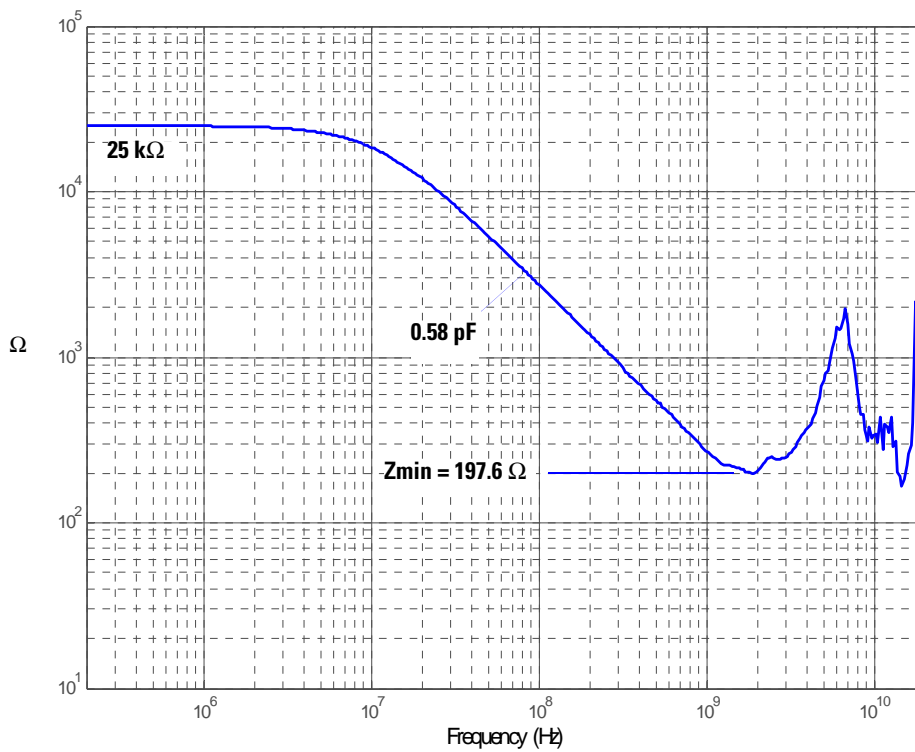
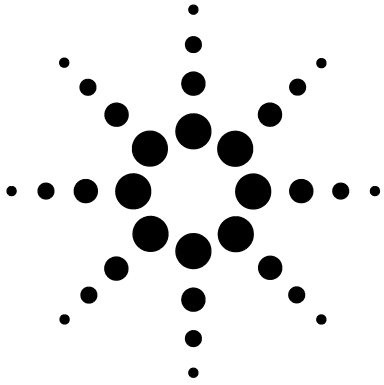


Figure 124 Graph of Vout/Vin frequency response when inputs driven in common (common mode rejection).

**6 1131A Performance Data Plots**  
**E2679A Single-Ended Solder-in Probe Head (Medium BW)**



**Figure 125 Magnitude plot of probe input impedance versus frequency.**



## 7

# 1132A Performance Data Plots

|  |     |
|--|-----|
| E2675A Differential Browser  | 148 |
| E2676A Single-Ended Browser  | 151 |
| E2677A Differential Solder-in Probe Head (Full BW)                 | 154 |
| E2677A Differential Solder-in Probe Head (Medium BW)               | 157 |
| E2678A Differential Socketed Probe Head (Full BW)                  | 160 |
| E2678A Differential Socketed Probe Head with Damped Wire Accessory | 163 |
| E2679A Single-Ended Solder-in Probe Head (Full BW)                 | 167 |
| E2679A Single-Ended Solder-in Probe Head (Medium BW)               | 170 |

This chapter provides graphs of the performance characteristics of the 1132A probes using the different probe heads that come with the E2668A single-ended and E2669A differential connectivity kits.

---

### NOTE

---

All rise times shown are measured from the 10% to the 90% amplitude levels.

## E2675A Differential Browser

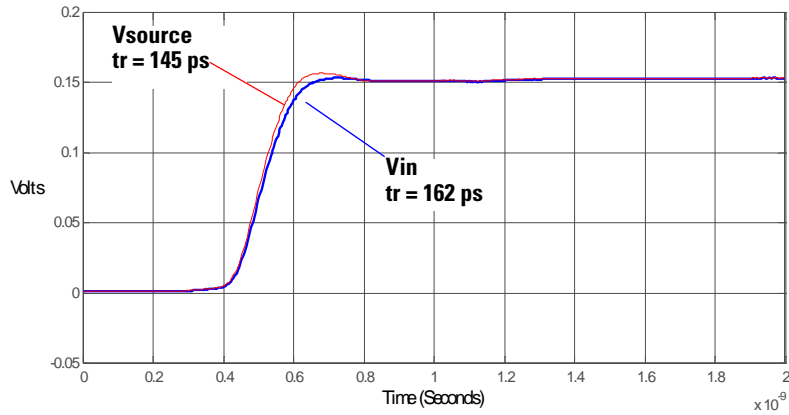


Figure 126 Graph of 25Ω 100 ps step generator with and without probe connected.

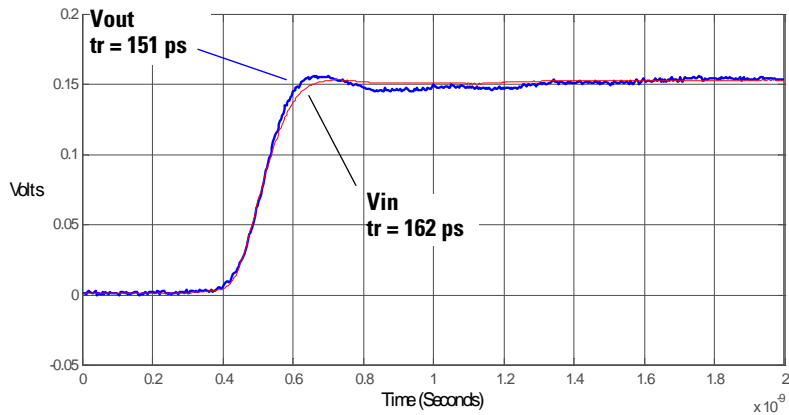


Figure 127 Graph of V<sub>in</sub> and V<sub>out</sub> of probe with a 25Ω 100 ps step generator.

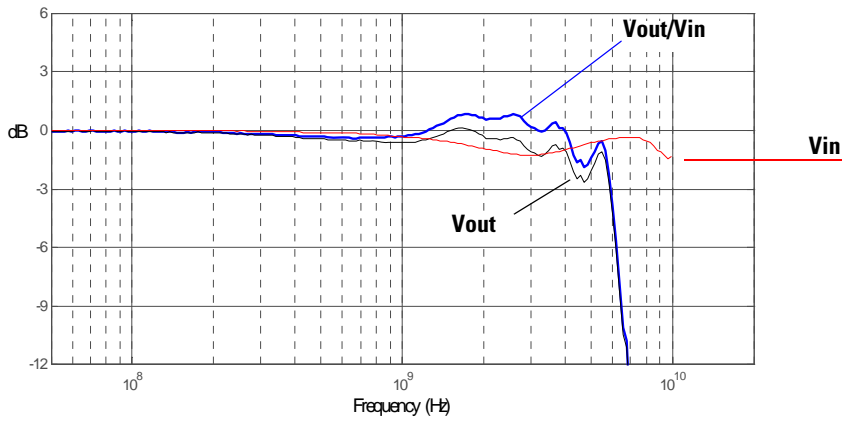


Figure 128 Graph of Vin and Vout of probe with a  $25\Omega$  source and Vout/Vin frequency response.

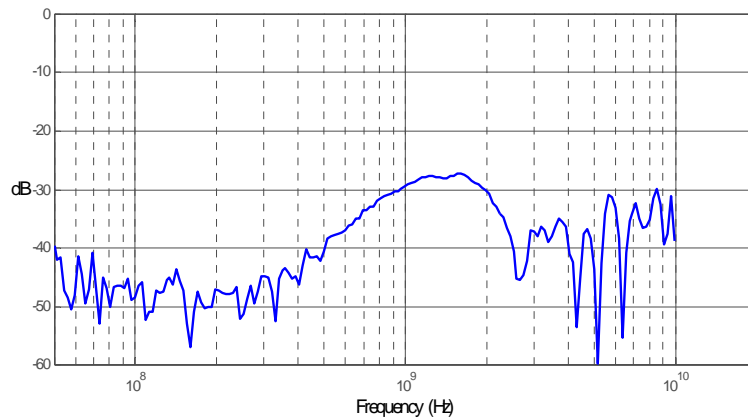


Figure 129 Graph of Vout/Vin frequency response when inputs driven in common (common mode rejection).

7 1132A Performance Data Plots  
E2675A Differential Browser

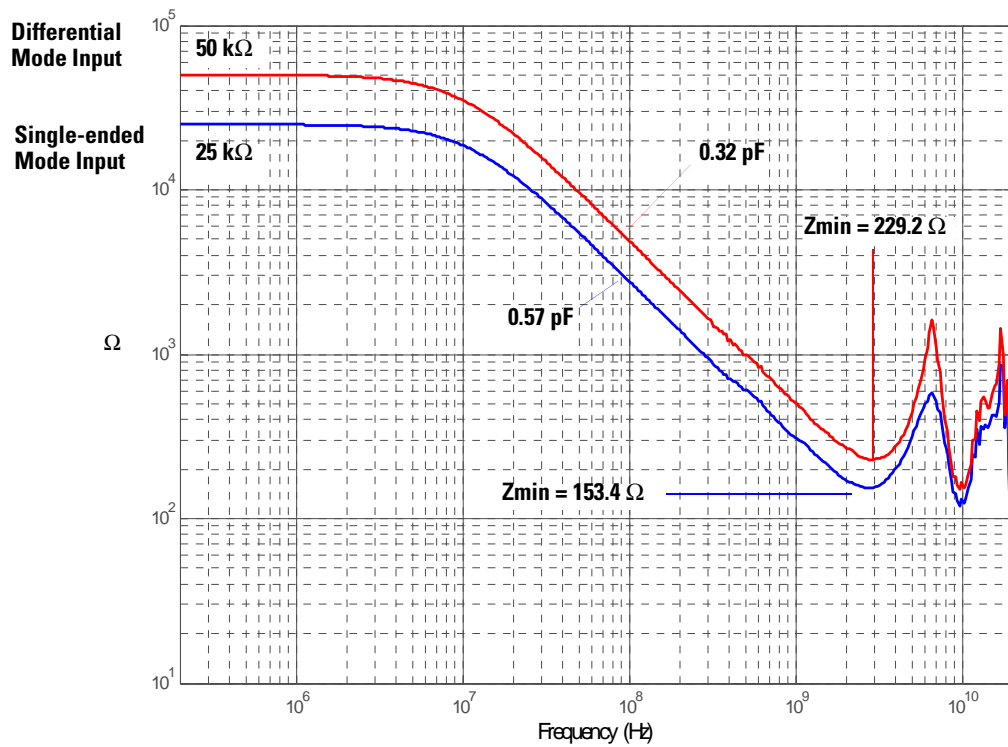


Figure 130 Magnitude plot of probe input impedance versus frequency.

## E2676A Single-Ended Browser

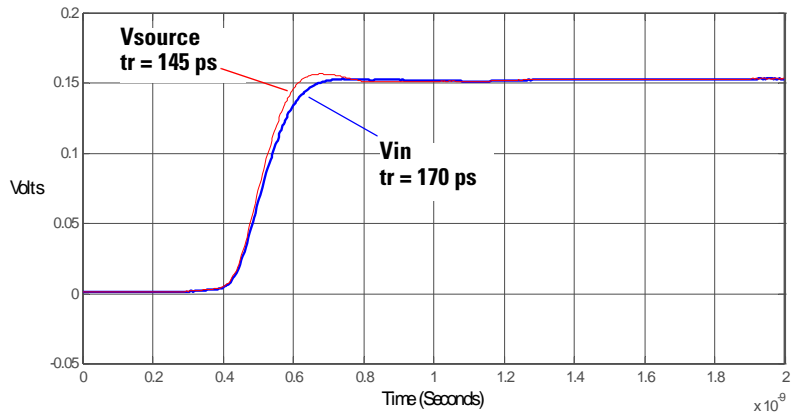


Figure 131 Graph of  $25\Omega$  100 ps step generator with and without probe connected.

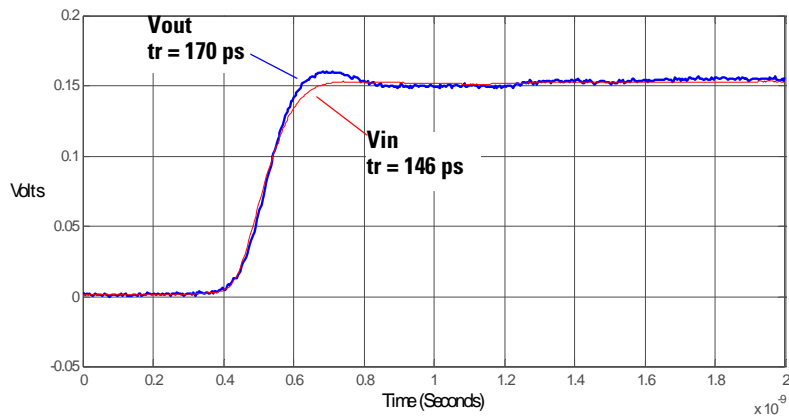
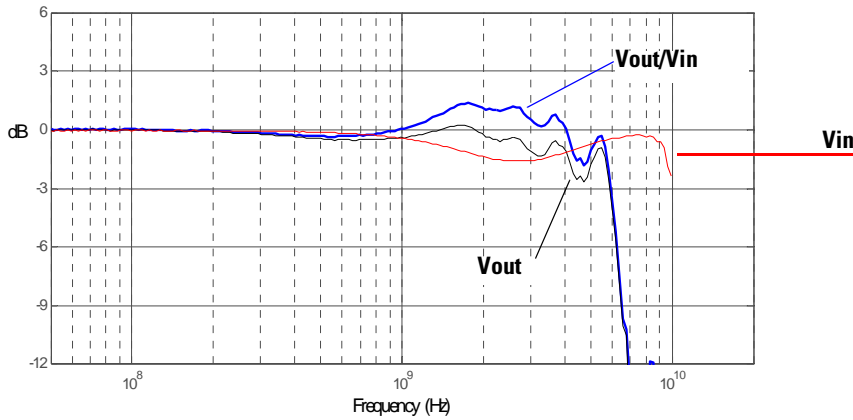
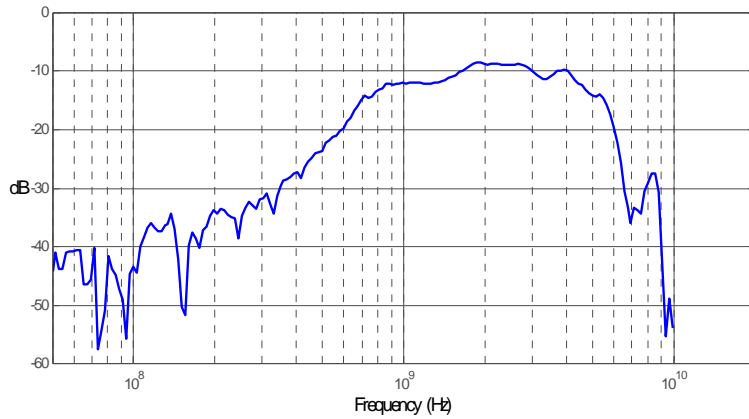


Figure 132 Graph of  $V_{in}$  and  $V_{out}$  of probe with a  $25\Omega$  100 ps step generator.

**7 1132A Performance Data Plots**  
**E2676A Single-Ended Browser**



**Figure 133** Graph of  $V_{in}$  and  $V_{out}$  of probe with a  $25\Omega$  source and  $V_{out}/V_{in}$  frequency response.



**Figure 134** Graph of  $V_{out}/V_{in}$  frequency response when inputs driven in common (common mode rejection).



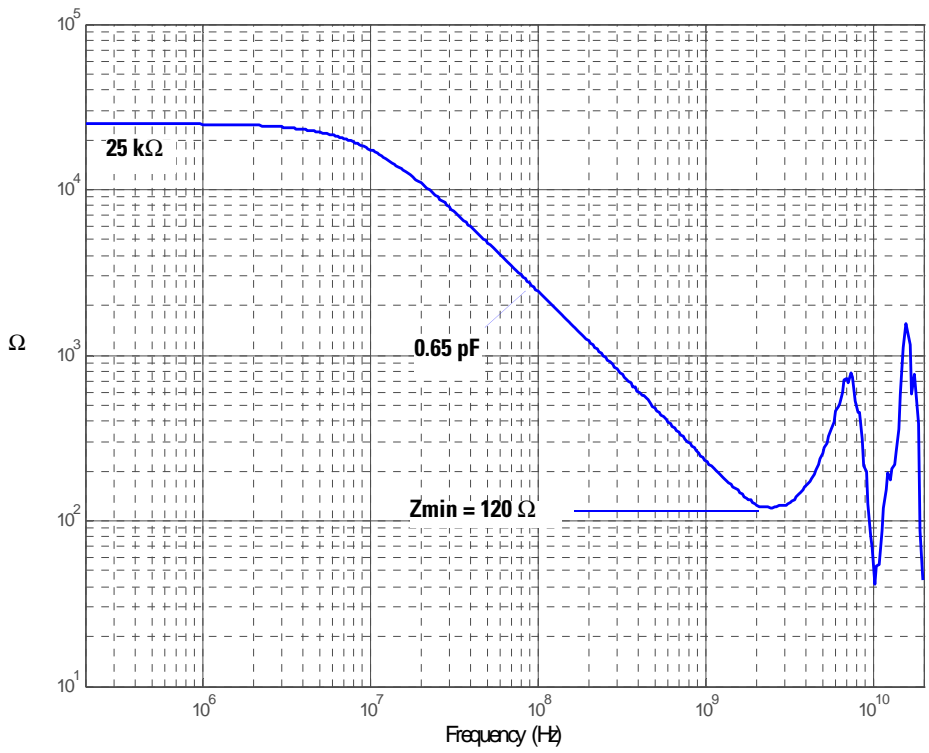


Figure 135 Magnitude plot of probe input impedance versus frequency.

## E2677A Differential Solder-in Probe Head (Full BW)

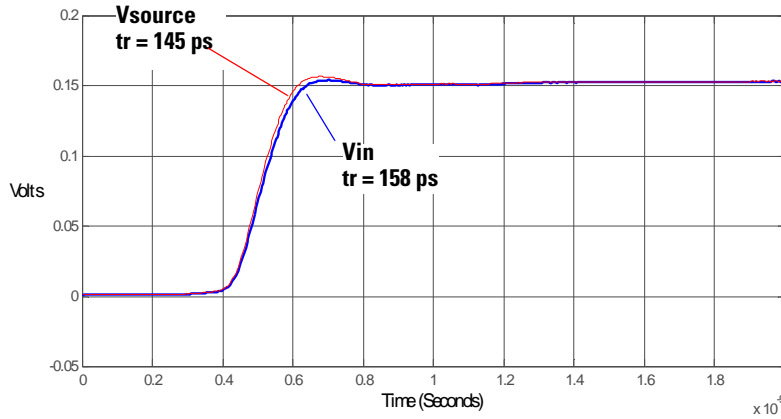


Figure 136 Graph of 25Ω 100 ps step generator with and without probe connected.

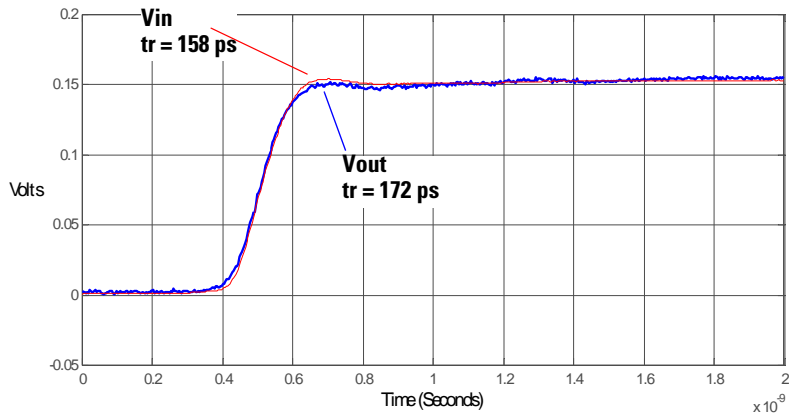


Figure 137 Graph of Vin and Vout of probe with a 25Ω 100 ps step generator.

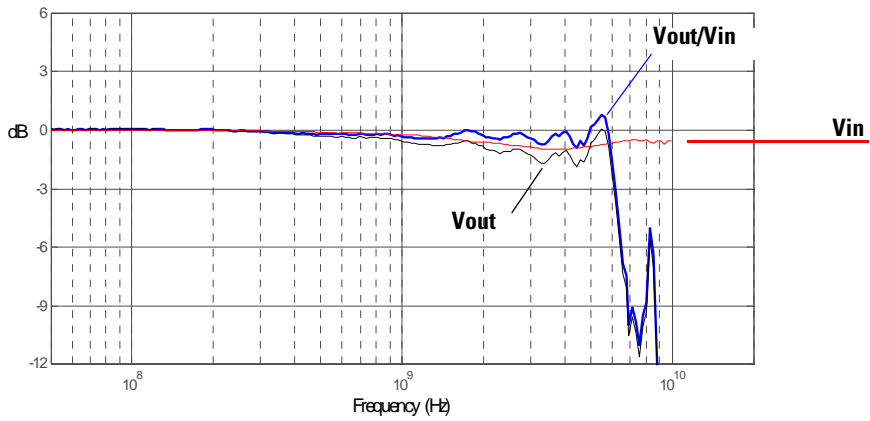


Figure 138 Graph of  $V_{in}$  and  $V_{out}$  of probe with a  $25\Omega$  source and  $V_{out}/V_{in}$  frequency response.

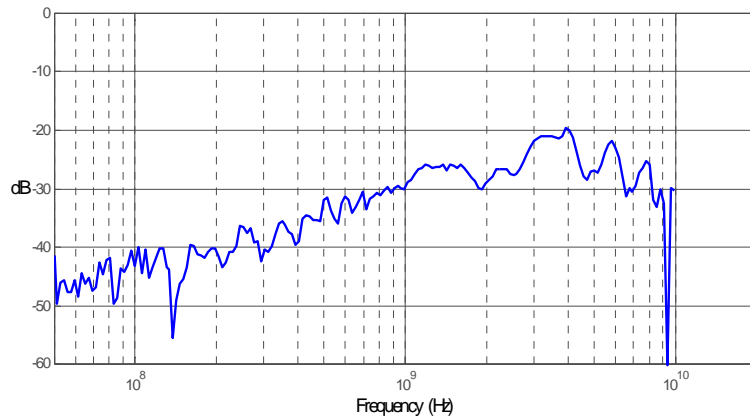
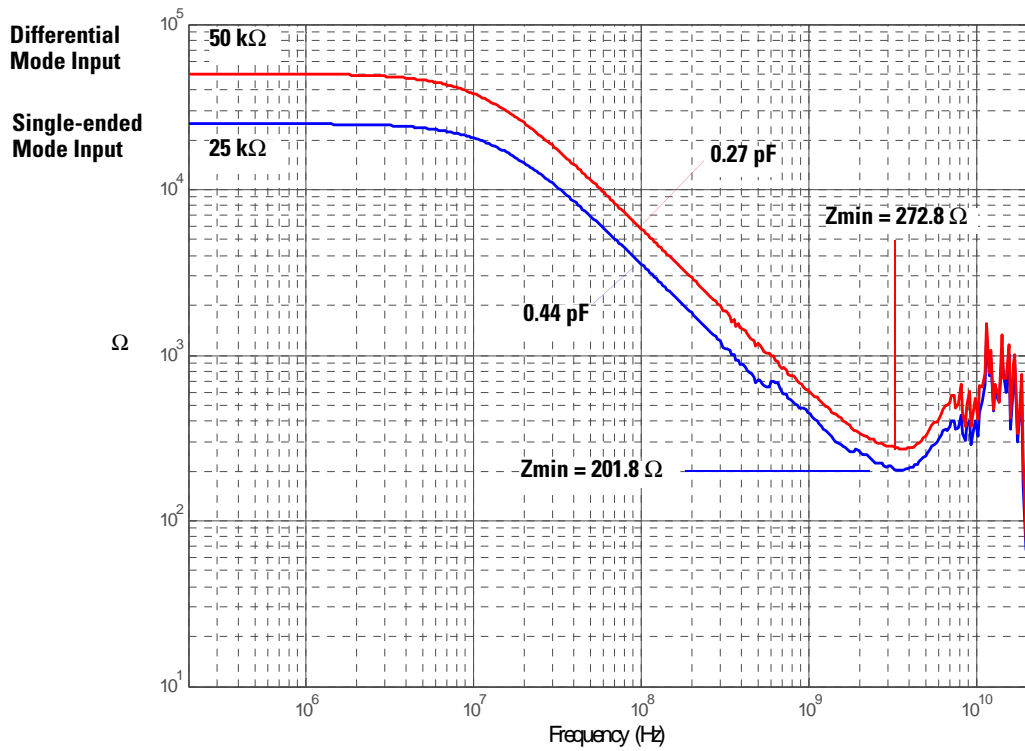


Figure 139 Graph of  $V_{out}/V_{in}$  frequency response when inputs driven in common (common mode rejection).

**7 1132A Performance Data Plots**  
E2677A Differential Solder-in Probe Head (Full BW)



**Figure 140 Magnitude plot of probe input impedance versus frequency.**

## E2677A Differential Solder-in Probe Head (Medium BW)

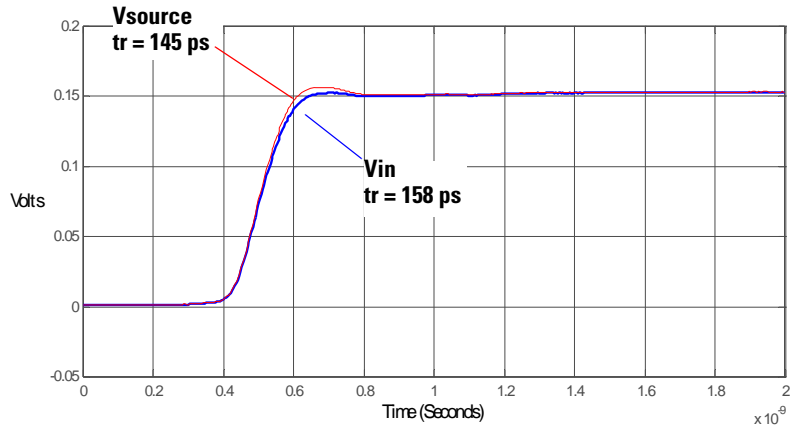


Figure 141 Graph of 25Ω 100 ps step generator with and without probe connected.

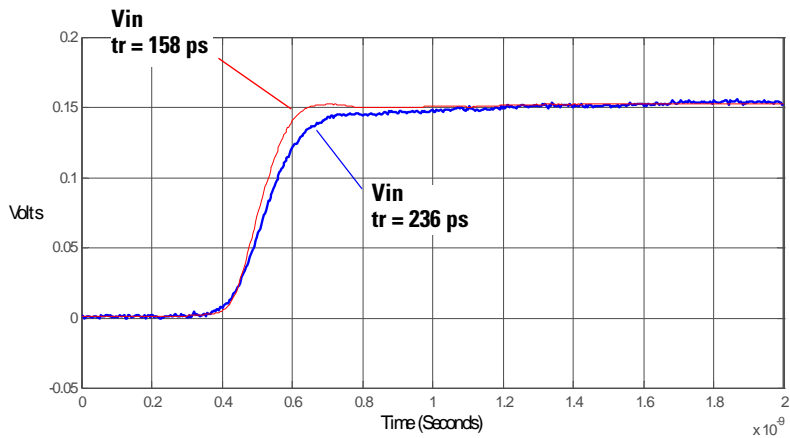
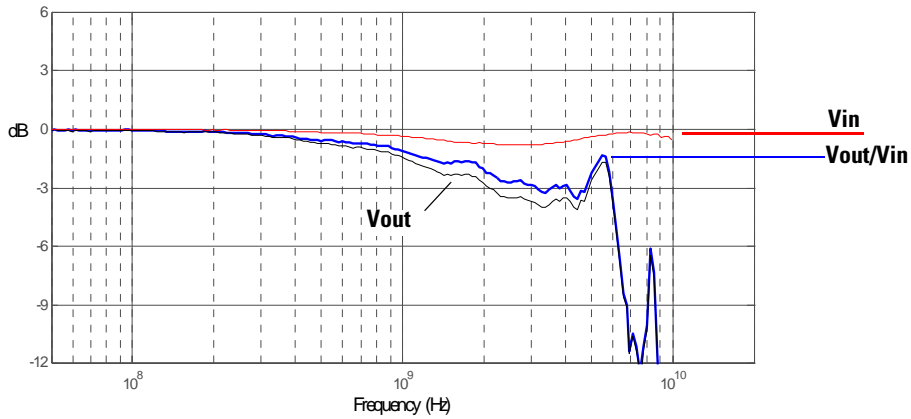
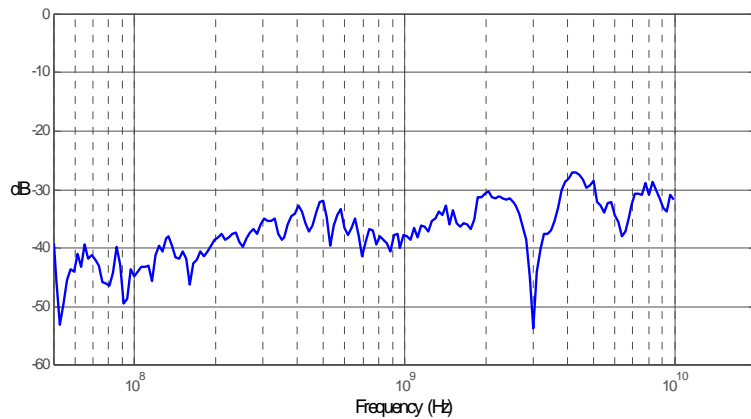


Figure 142 Graph of Vin and Vout of probe with a 25Ω 100 ps step generator.

**7 1132A Performance Data Plots**  
E2677A Differential Solder-in Probe Head (Medium BW)



**Figure 143** Graph of  $V_{in}$  and  $V_{out}$  of probe with a  $25\Omega$  source and  $V_{out}/V_{in}$  frequency response.



**Figure 144** Graph of  $V_{out}/V_{in}$  frequency response when inputs driven in common (common mode rejection).

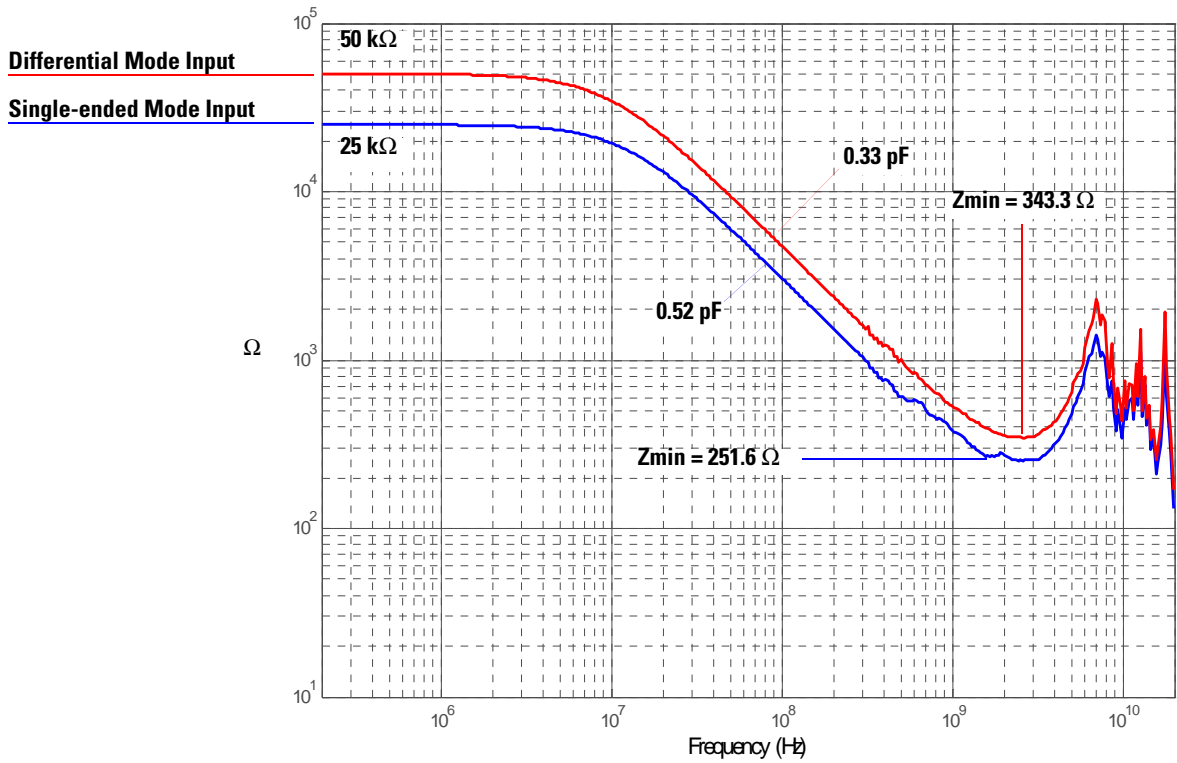


Figure 145 Magnitude plot of probe input impedance versus frequency.

## E2678A Differential Socketed Probe Head (Full BW)

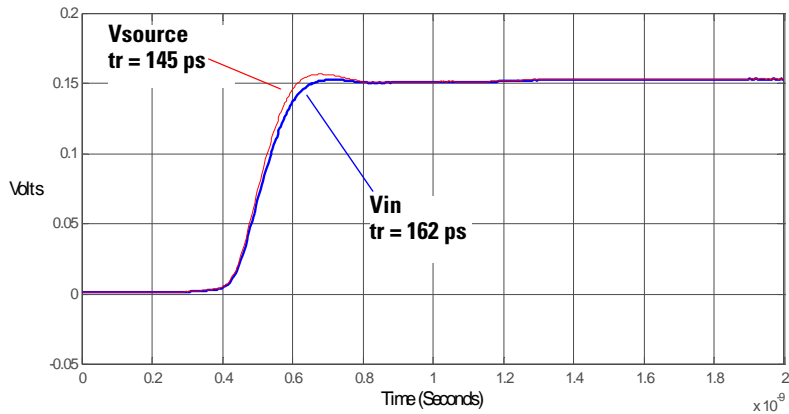


Figure 146 Graph of 25Ω 100 ps step generator with and without probe connected.

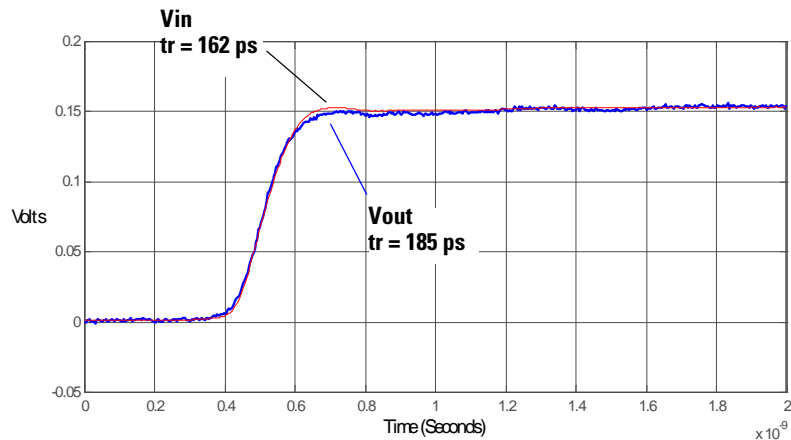


Figure 147 Graph of V<sub>in</sub> and V<sub>out</sub> of probe with a 25Ω 100 ps step generator.



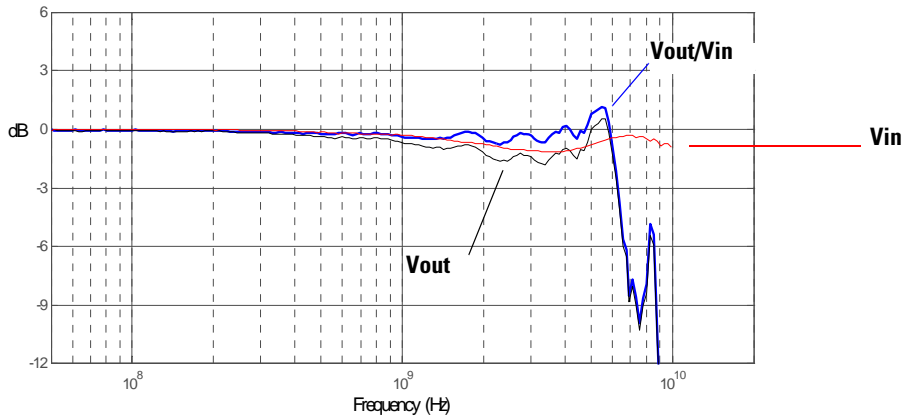


Figure 148 Graph of  $V_{in}$  and  $V_{out}$  of probe with a  $25\Omega$  source and  $V_{out}/V_{in}$  frequency response.

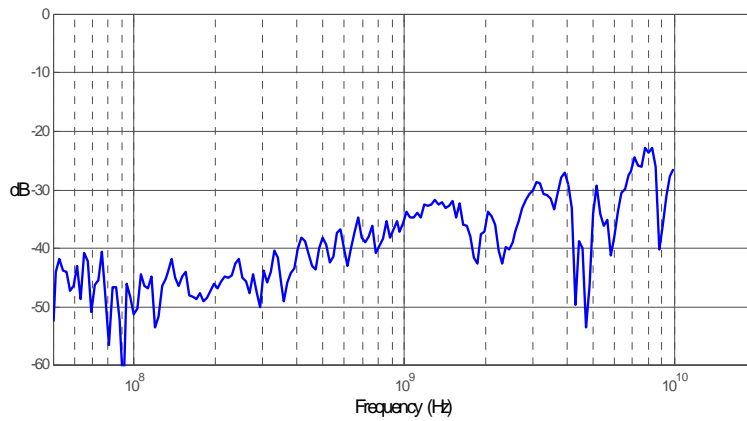
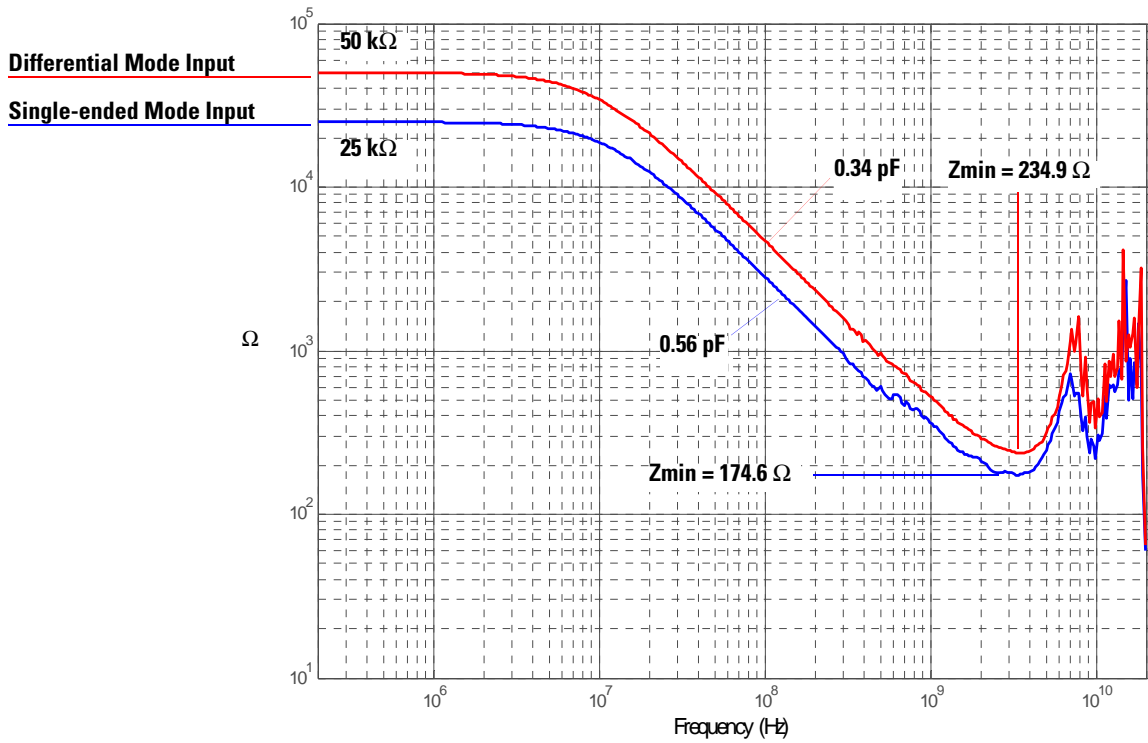


Figure 149 Graph of  $V_{out}/V_{in}$  frequency response when inputs driven in common (common mode rejection).

**7 1132A Performance Data Plots**  
E2678A Differential Socketed Probe Head (Full BW)



**Figure 150** Magnitude plot of probe input impedance versus frequency.

## E2678A Differential Socketed Probe Head with Damped Wire Accessory

### NOTE

Due to reflections on the long wire accessories, signals being probed should be limited to approximately  $\cong 240$  ps rise time measured at the 10% and 90% amplitude levels. This is equivalent to approximately  $\cong 1.5$  GHz bandwidth.

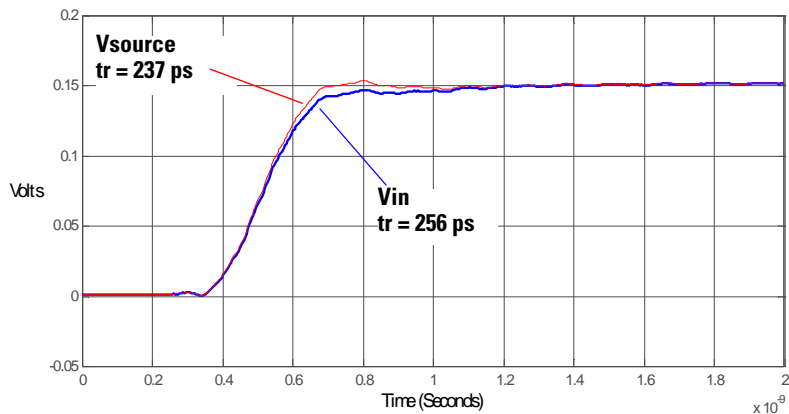
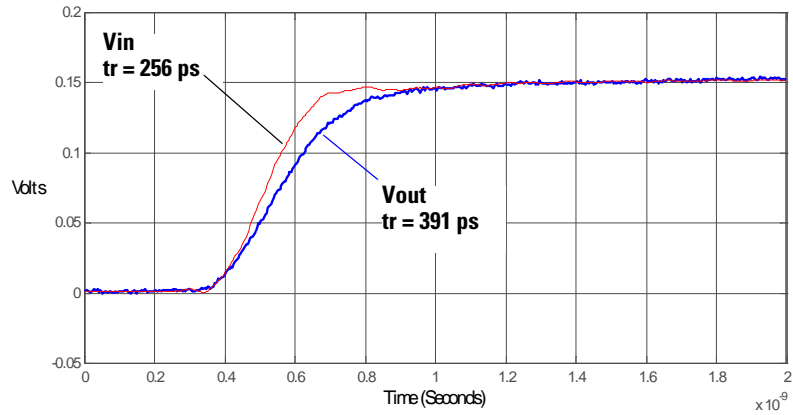
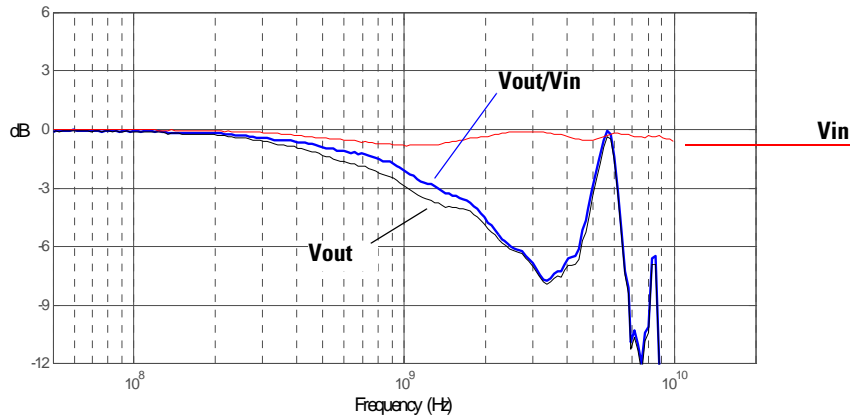


Figure 151 Graph of  $25\Omega$  240 ps step generator with and without probe connected.

**7 1132A Performance Data Plots**  
E2678A Differential Socketed Probe Head with Damped Wire Accessory

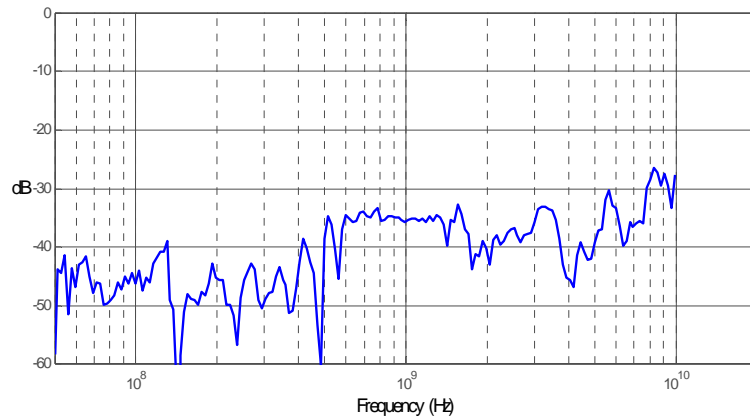


**Figure 152** Graph of Vin and Vout of probe with a 25Ω 240 ps step generator.



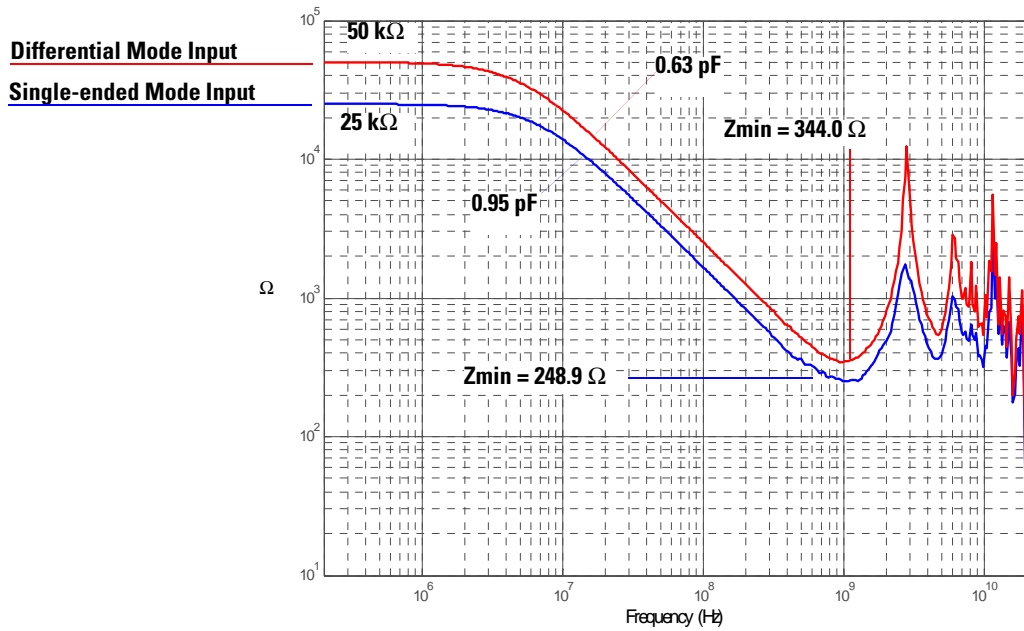
**Figure 153** Graph of Vin and Vout of probe with a 25Ω source and Vout/Vin frequency response.

## E2678A Differential Socketed Probe Head with Damped Wire Accessory



**Figure 154** Graph of  $V_{out}/V_{in}$  frequency response when inputs driven in common (common mode rejection).

**7 1132A Performance Data Plots**  
E2678A Differential Socketed Probe Head with Damped Wire Accessory



**Figure 155 Magnitude plot of probe input impedance versus frequency.**

## E2679A Single-Ended Solder-in Probe Head (Full BW)

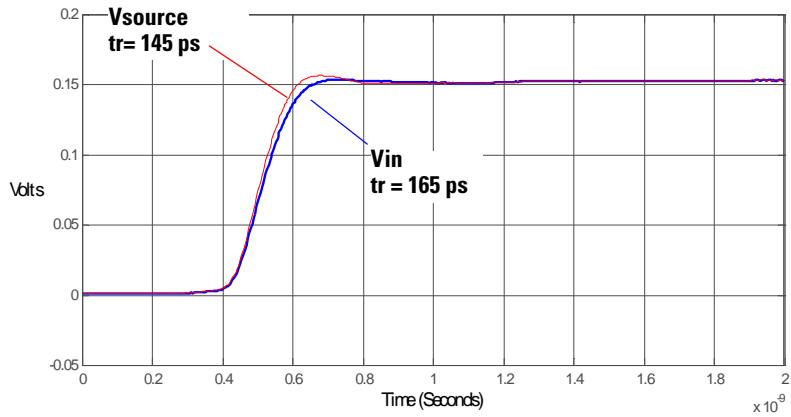


Figure 156 Graph of 25Ω 100 ps step generator with and without probe connected.

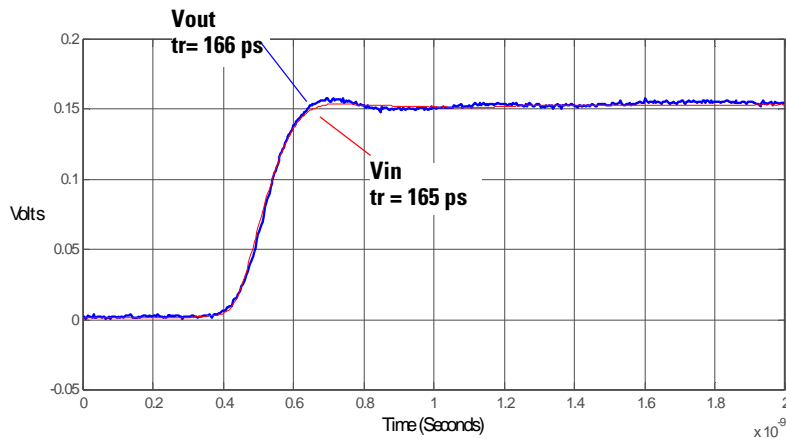
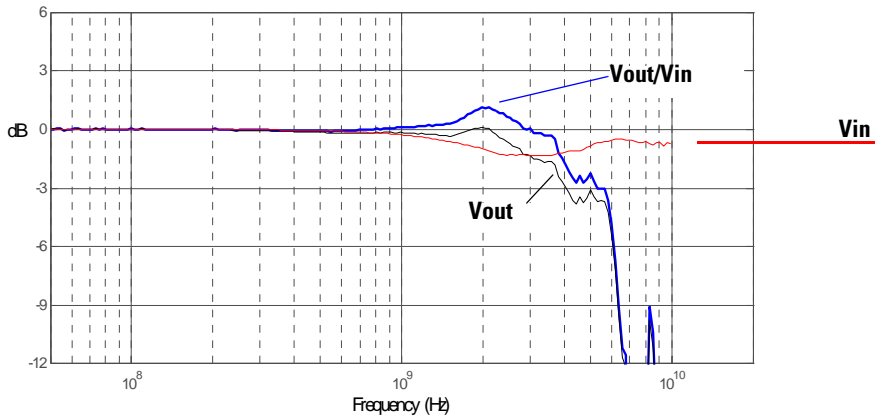
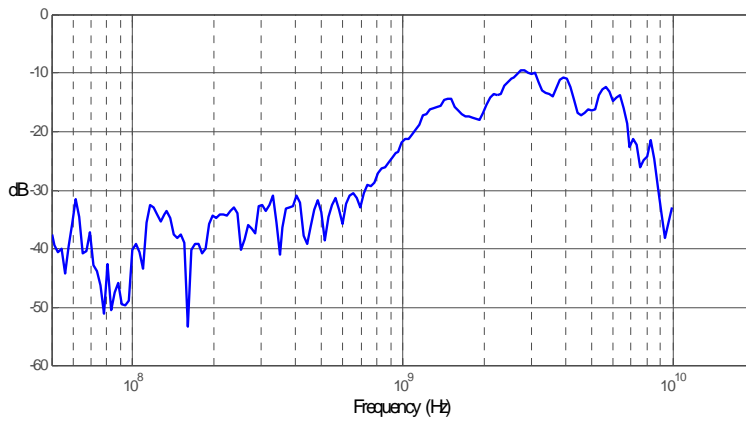


Figure 157 Graph of Vin and Vout of probe with a 25Ω 100 ps step generator.

**7 1132A Performance Data Plots**  
E2679A Single-Ended Solder-in Probe Head (Full BW)



**Figure 158** Graph of  $V_{in}$  and  $V_{out}$  of probe with a  $25\Omega$  source and  $V_{out}/V_{in}$  frequency response.



**Figure 159** Graph of  $V_{out}/V_{in}$  frequency response when inputs driven in common (common mode rejection).



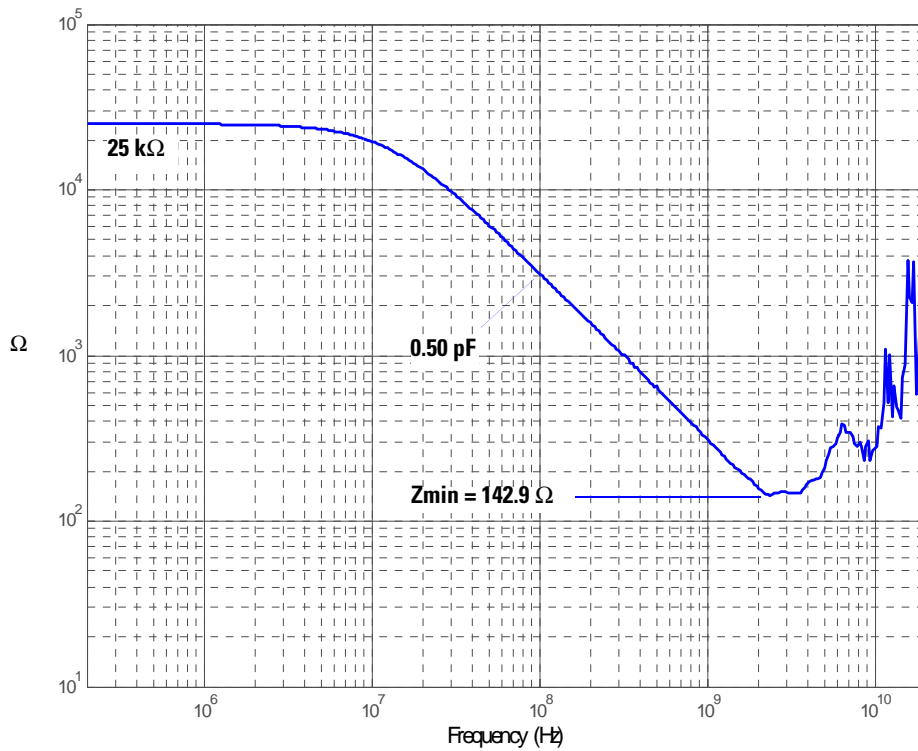


Figure 160 Magnitude plot of probe input impedance versus frequency.

## E2679A Single-Ended Solder-in Probe Head (Medium BW)

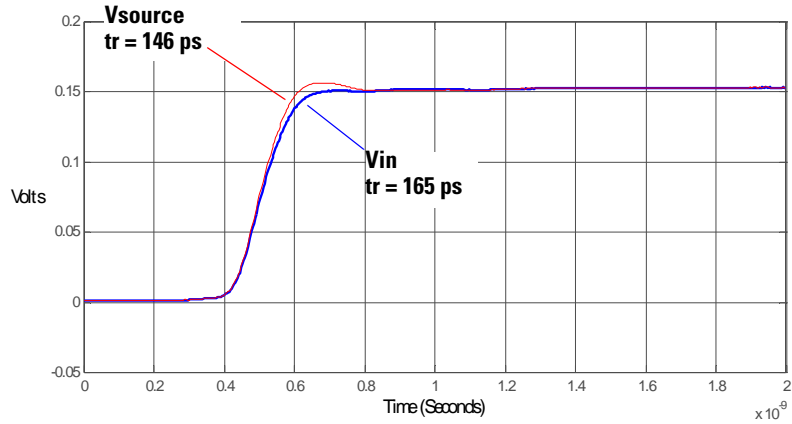


Figure 161 Graph of 25Ω 100 ps step generator with and without probe connected.

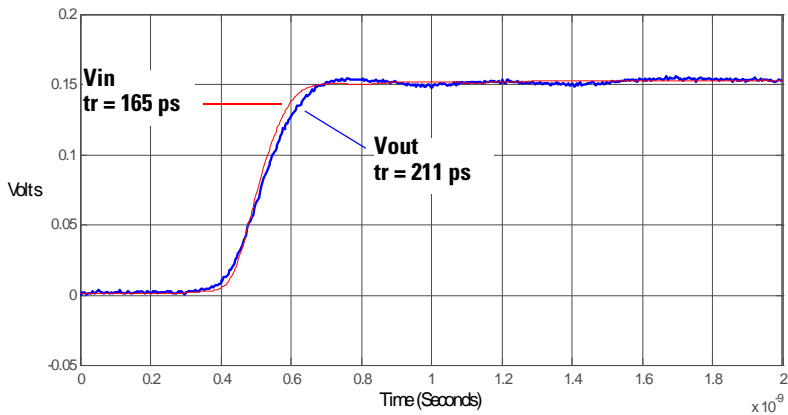


Figure 162 Graph of Vin and Vout of probe with a 25Ω 100 ps step generator.

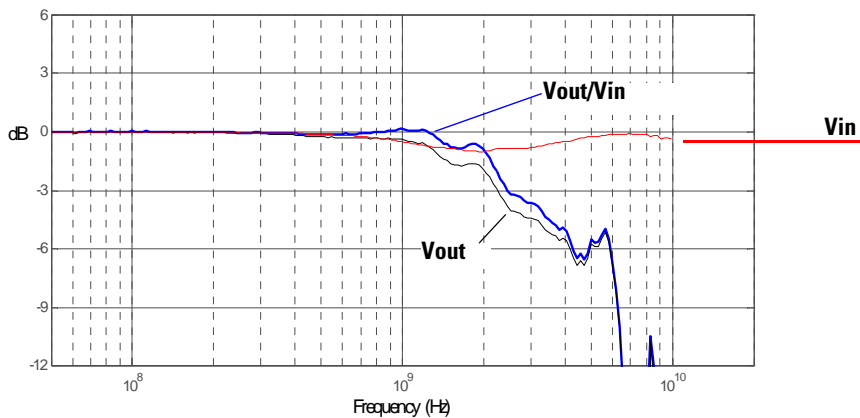


Figure 163 Graph of  $V_{in}$  and  $V_{out}$  of probe with a  $25\Omega$  source and  $V_{out}/V_{in}$  frequency response.

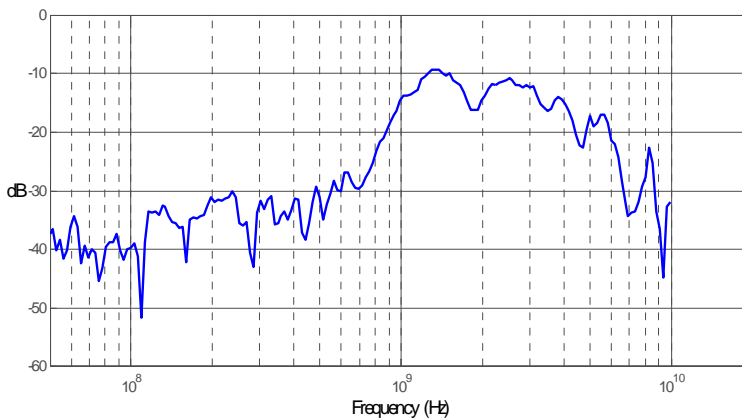
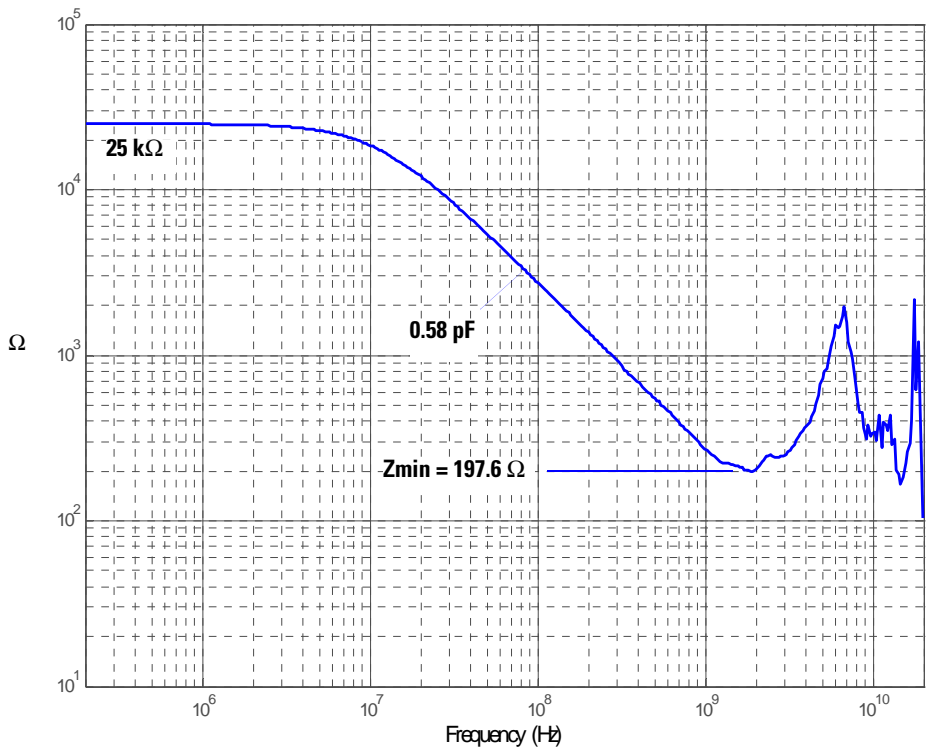
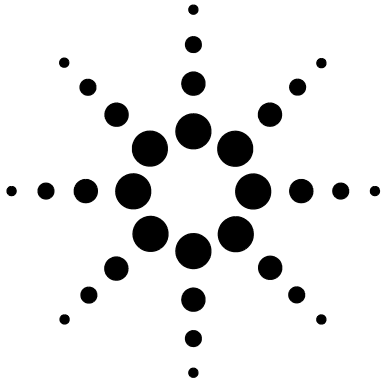


Figure 164 Graph of  $V_{out}/V_{in}$  frequency response when inputs driven in common (common mode rejection).

**7 1132A Performance Data Plots**  
**E2679A Single-Ended Solder-in Probe Head (Medium BW)**



**Figure 165 Magnitude plot of probe input impedance versus frequency.**



## 8

# 1134A Performance Data Plots

|  |     |
|--|-----|
| E2675A Differential Browser  | 174 |
| E2676A Single-Ended Browser  | 177 |
| E2677A Differential Solder-in Probe Head (Full BW)                 | 180 |
| E2677A Differential Solder-in Probe Head (Medium BW)               | 183 |
| E2678A Differential Socketed Probe Head (Full BW)                  | 186 |
| E2678A Differential Socketed Probe Head with Damped Wire Accessory | 189 |
| E2679A Single-Ended Solder-in Probe Head (Full BW)                 | 193 |
| E2679A Single-Ended Solder-in Probe Head (Medium BW)               | 196 |
| N5380B SMA Probe Head  | 199 |

This chapter provides graphs of the performance characteristics of the 1134A probes using the different probe heads that come with the E2668A single-ended and E2669A differential connectivity kits.

---

### NOTE

---

All rise times shown are measured from the 10% to the 90% amplitude levels.

## E2675A Differential Browser

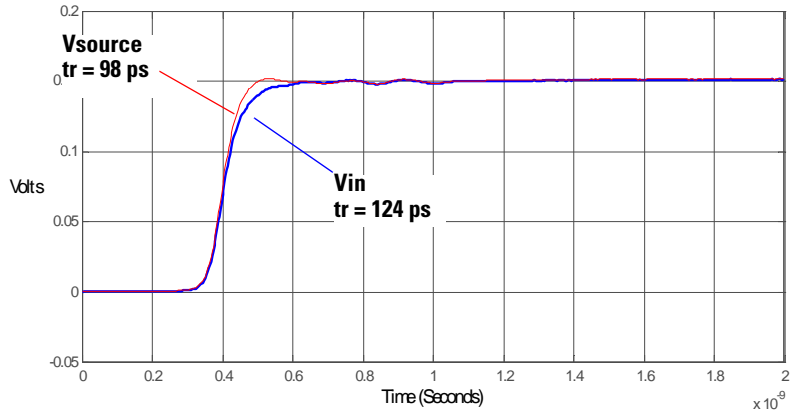


Figure 166 Graph of 25Ω 100 ps step generator with and without probe connected.

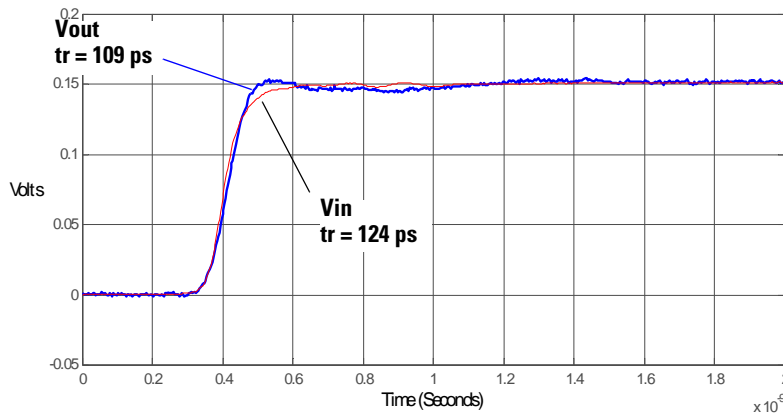


Figure 167 Graph of Vin and Vout of probe with a 25Ω 100 ps step generator.

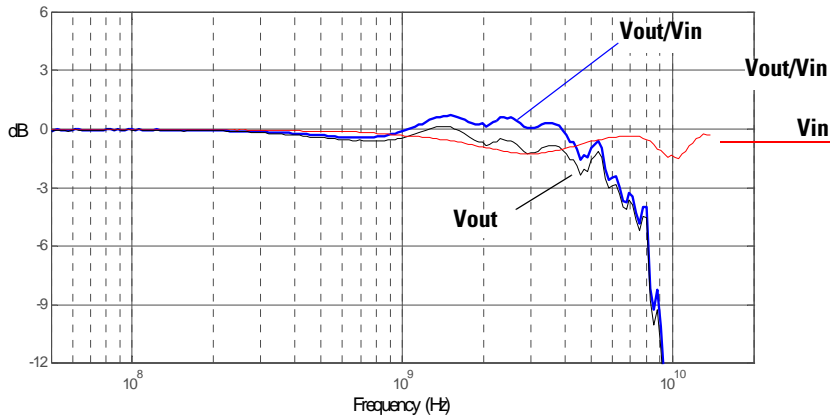


Figure 168 Graph of  $V_{in}$  and  $V_{out}$  of probe with a  $25\Omega$  source and  $V_{out}/V_{in}$  frequency response.

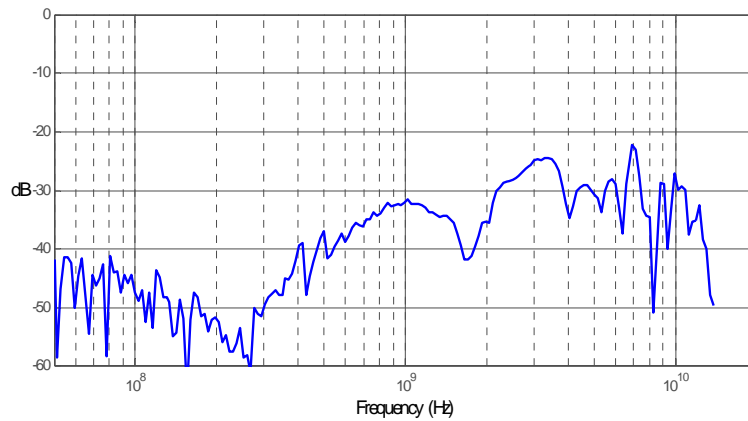
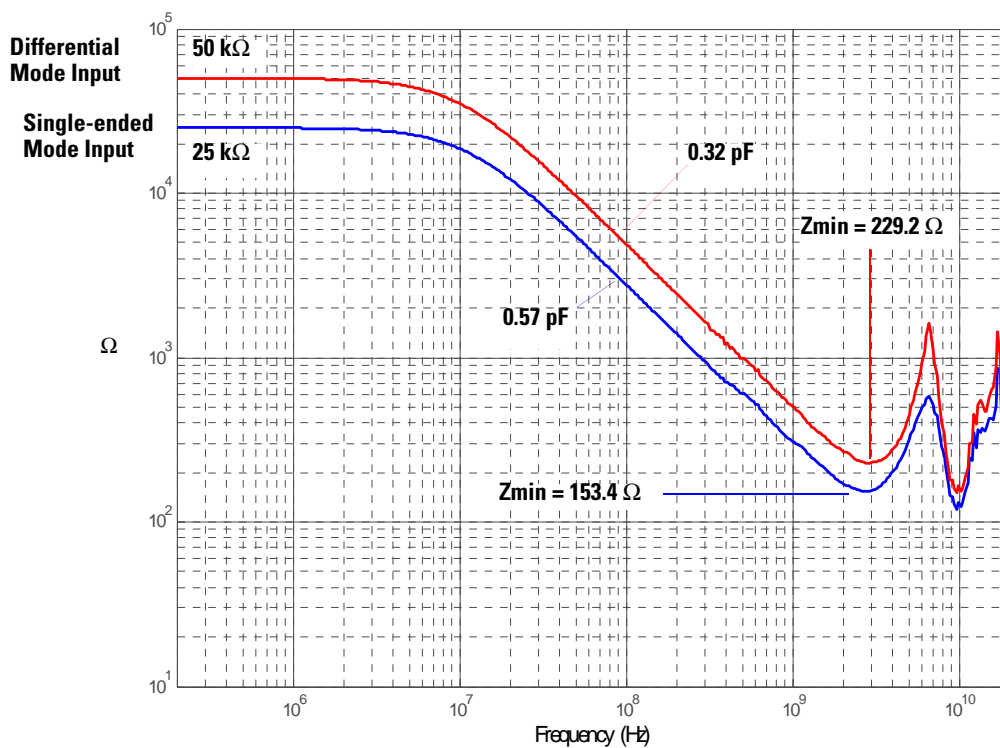


Figure 169 Graph of  $V_{out}/V_{in}$  frequency response when inputs driven in common (common mode rejection).

**8 1134A Performance Data Plots**  
E2675A Differential Browser



**Figure 170** Magnitude plot of probe input impedance versus frequency.



## E2676A Single-Ended Browser

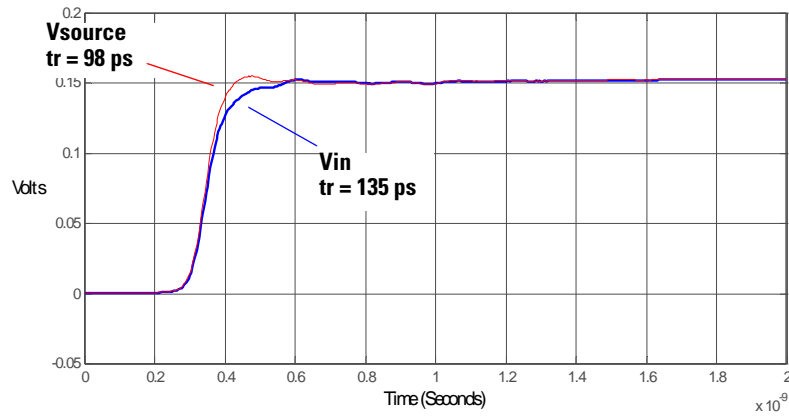


Figure 171 Graph of  $25\Omega$  100 ps step generator with and without probe connected.

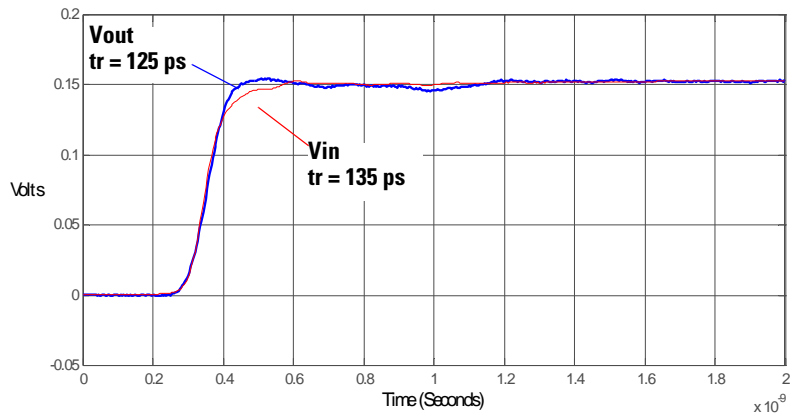
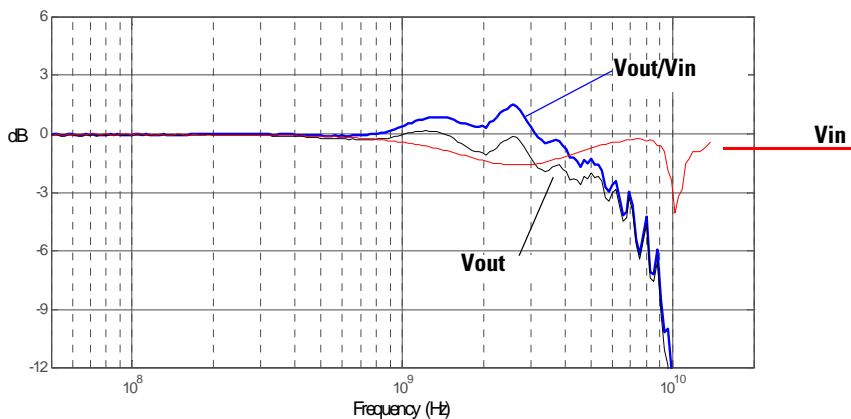
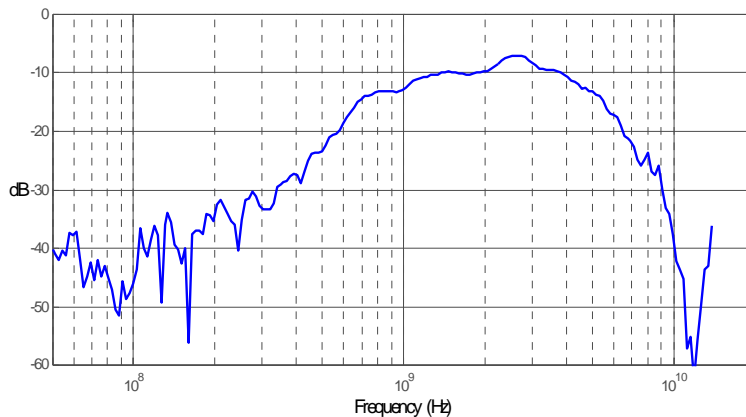


Figure 172 Graph of  $V_{in}$  and  $V_{out}$  of probe with a  $25\Omega$  100 ps step generator.

**8 1134A Performance Data Plots**  
E2676A Single-Ended Browser



**Figure 173** Graph of  $V_{in}$  and  $V_{out}$  of probe with a  $25\Omega$  source and  $V_{out}/V_{in}$  frequency response.



**Figure 174** Graph of  $V_{out}/V_{in}$  frequency response when inputs driven in common (common mode rejection).

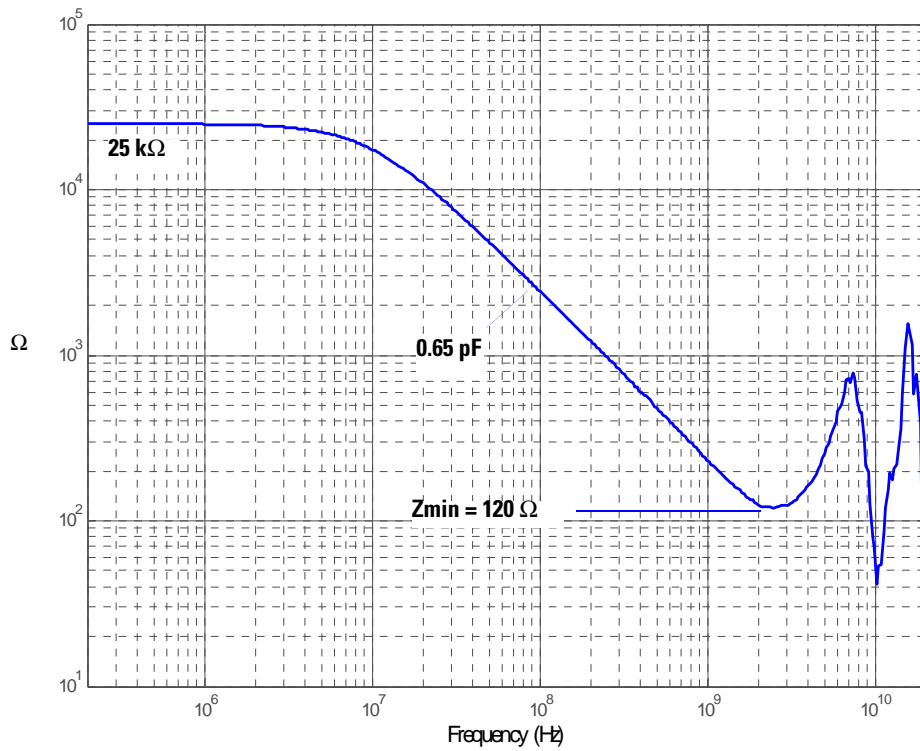


Figure 175 Magnitude plot of probe input impedance versus frequency.

## E2677A Differential Solder-in Probe Head (Full BW)

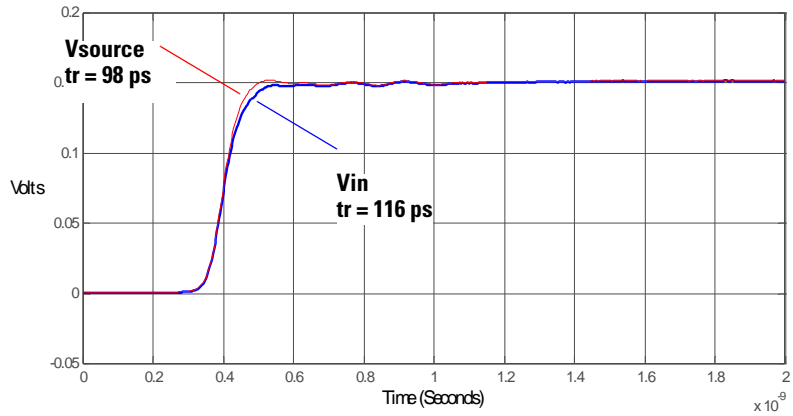


Figure 176 Graph of 25Ω 100 ps step generator with and without probe connected

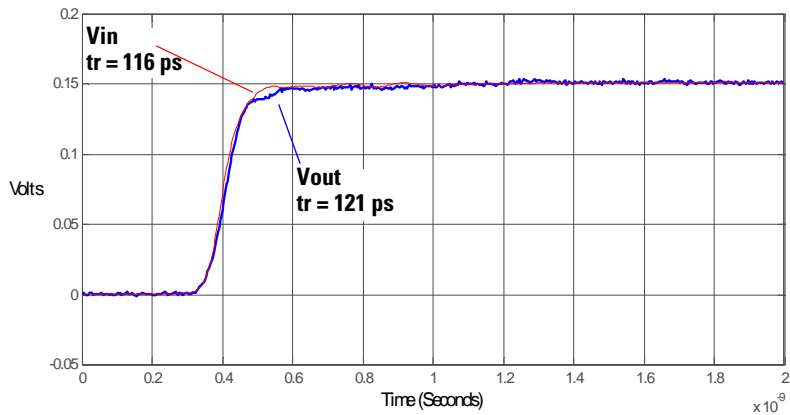


Figure 177 Graph of Vin and Vout of probe with a 25Ω 100 ps step generator.

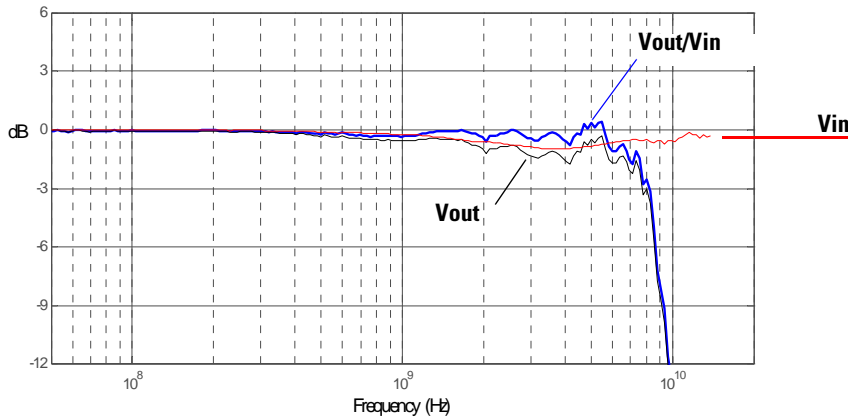


Figure 178 Graph of  $V_{in}$  and  $V_{out}$  of probe with a  $25\Omega$  source and  $V_{out}/V_{in}$  frequency response.

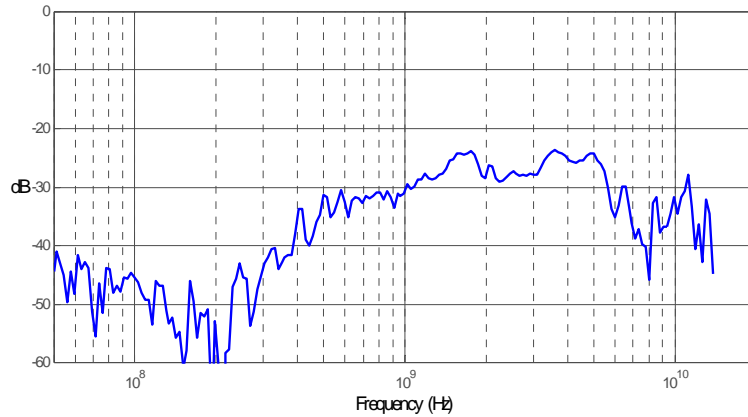
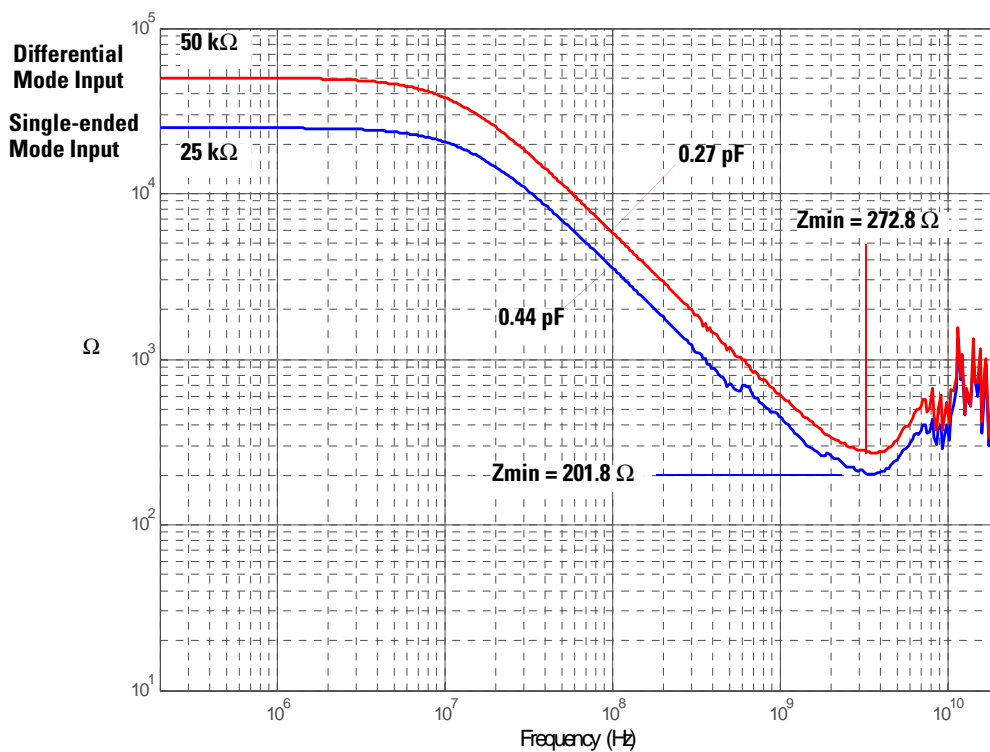


Figure 179 Graph of  $V_{out}/V_{in}$  frequency response when inputs driven in common (common mode rejection).

**8 1134A Performance Data Plots**  
E2677A Differential Solder-in Probe Head (Full BW)



**Figure 180 Magnitude plot of probe input impedance versus frequency.**

## E2677A Differential Solder-in Probe Head (Medium BW)

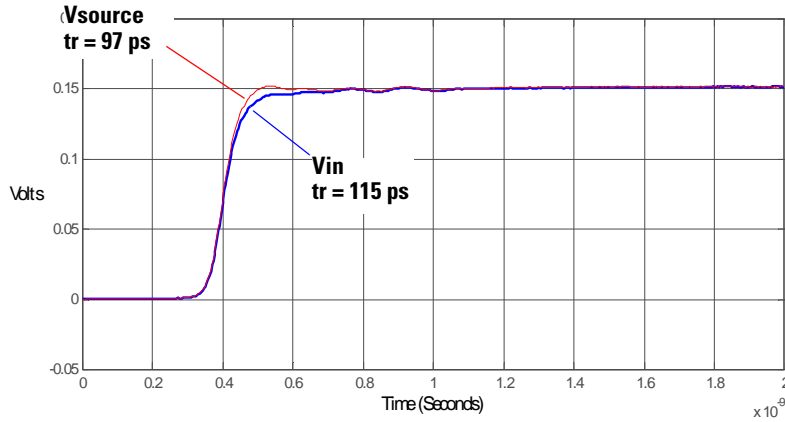


Figure 181 Graph of 25Ω 100 ps step generator with and without probe connected.

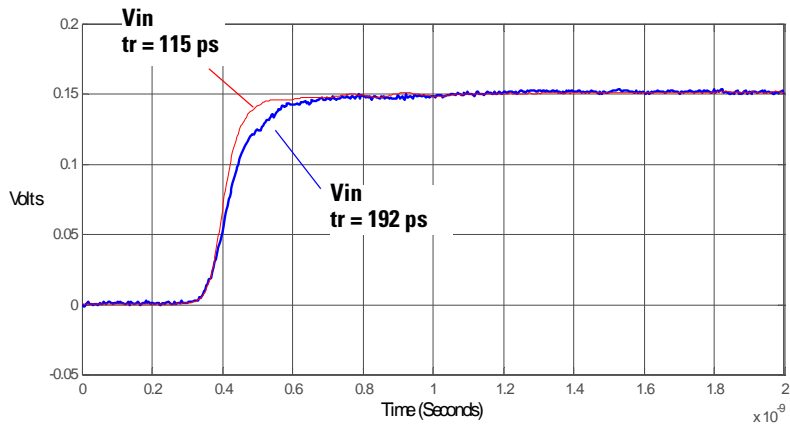
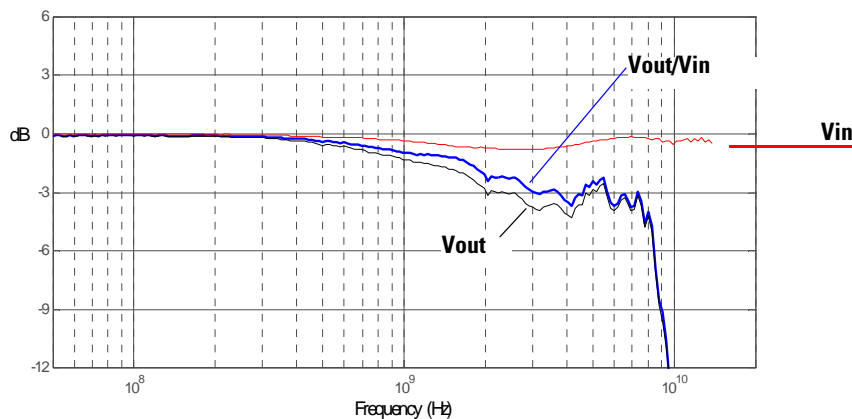
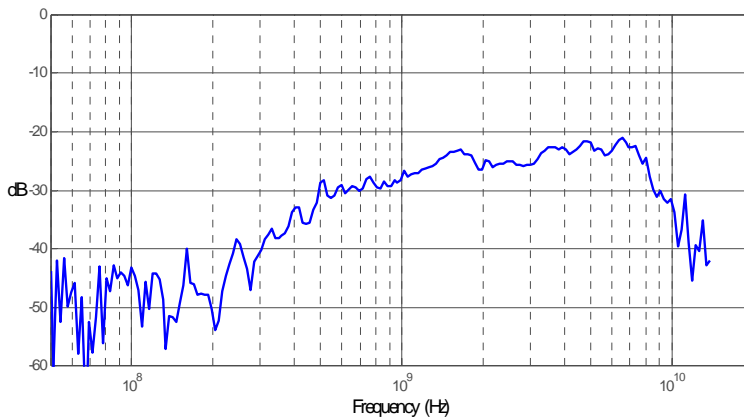


Figure 182 Graph of Vin and Vout of probe with a 25Ω 100 ps step generator.

**8 1134A Performance Data Plots**  
E2677A Differential Solder-in Probe Head (Medium BW)



**Figure 183** Graph of  $V_{in}$  and  $V_{out}$  of probe with a  $25\Omega$  source and  $V_{out}/V_{in}$  frequency response.



**Figure 184** Graph of  $V_{out}/V_{in}$  frequency response when inputs driven in common (common mode rejection).



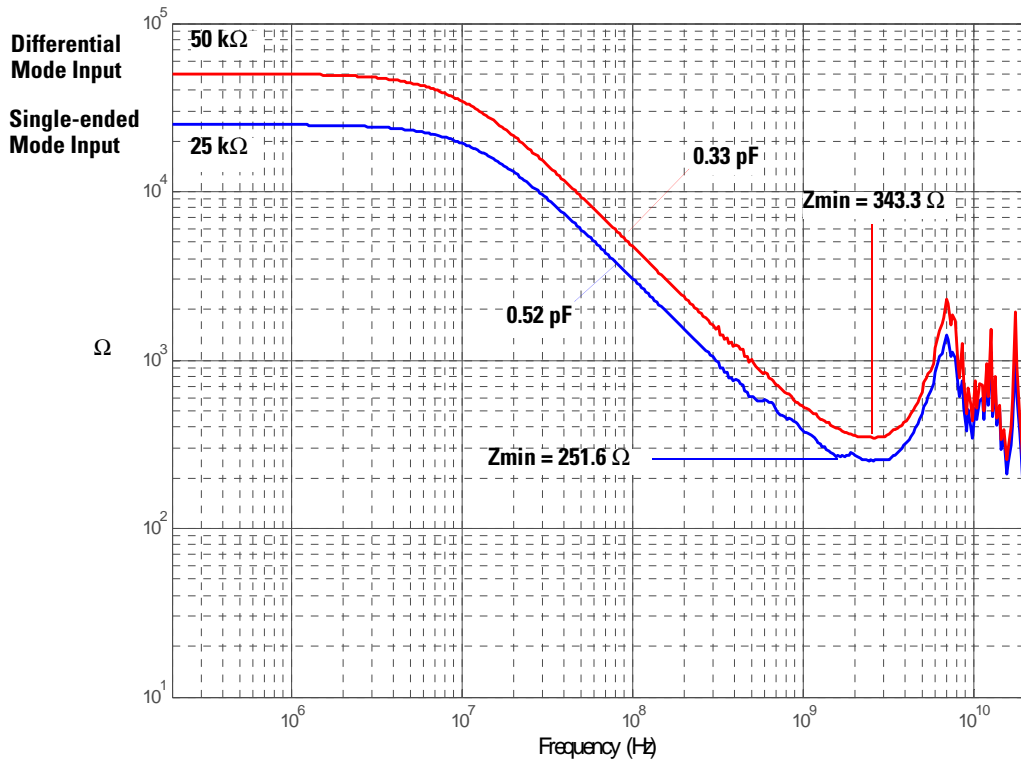


Figure 185 Magnitude plot of probe input impedance versus frequency.

## E2678A Differential Socketed Probe Head (Full BW)

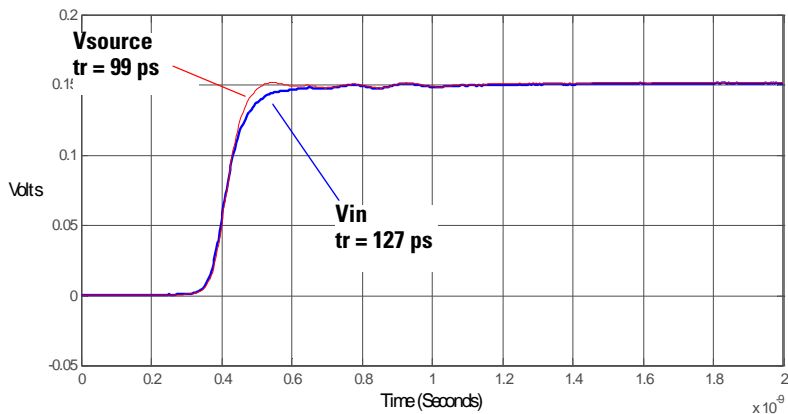


Figure 186 Graph of 25Ω 100 ps step generator with and without probe connected.

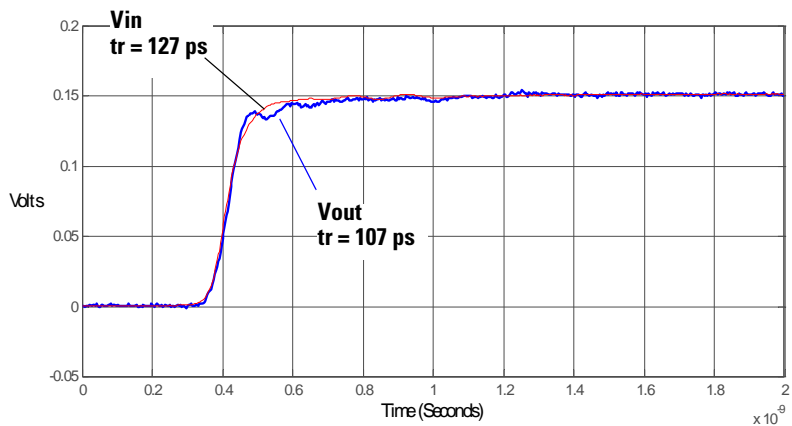


Figure 187 Graph of  $V_{in}$  and  $V_{out}$  of probe with a 25Ω 100 ps step generator.

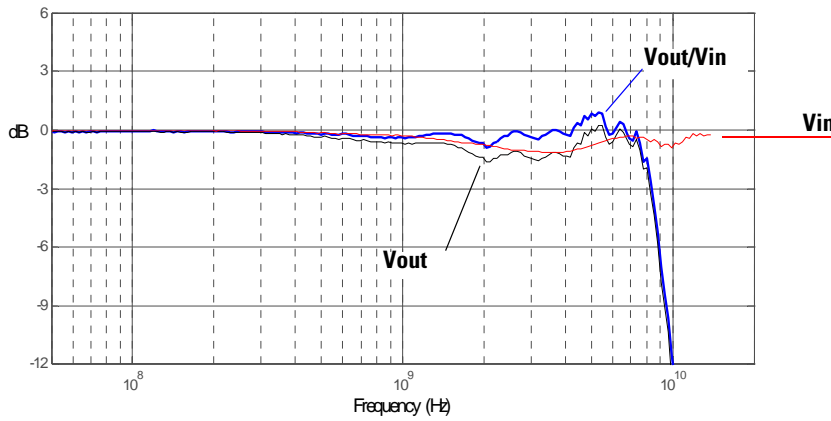


Figure 188 Graph of  $V_{in}$  and  $V_{out}$  of probe with a  $25\Omega$  source and  $V_{out}/V_{in}$  frequency response.

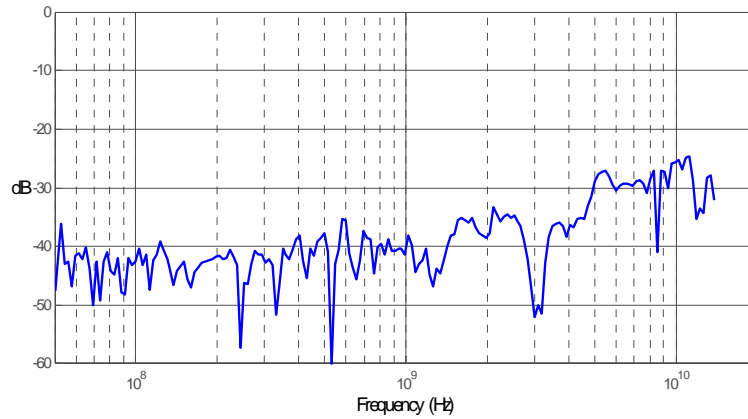
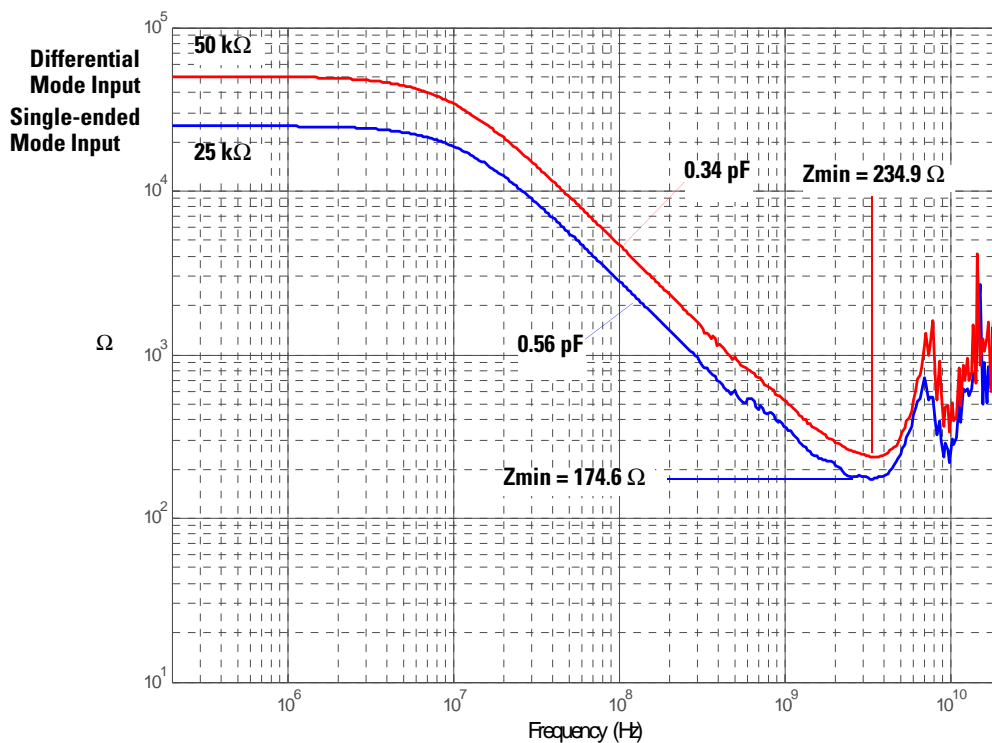


Figure 189 Graph of  $V_{out}/V_{in}$  frequency response when inputs driven in common (common mode rejection).

**8 1134A Performance Data Plots**  
E2678A Differential Socketed Probe Head (Full BW)



**Figure 190 Magnitude plot of probe input impedance versus frequency.**

## E2678A Differential Socketed Probe Head with Damped Wire Accessory

### NOTE

Due to reflections on the long wire accessories, signals being probed should be limited to approximately  $\cong 240$  ps rise time measured at the 10% and 90% amplitude levels. This is equivalent to approximately  $\cong 1.5$  GHz bandwidth.

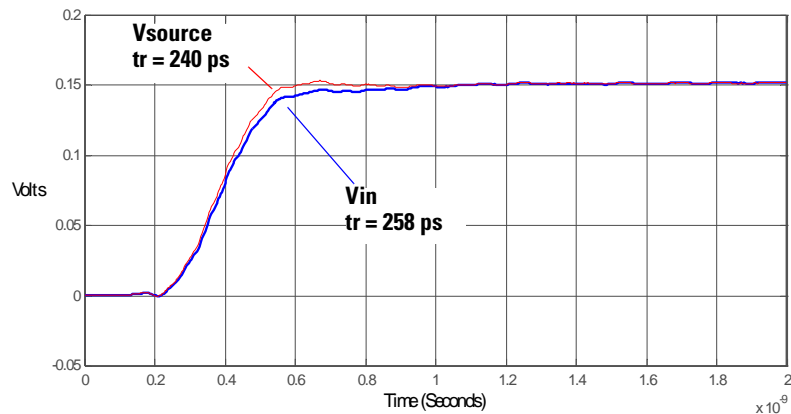
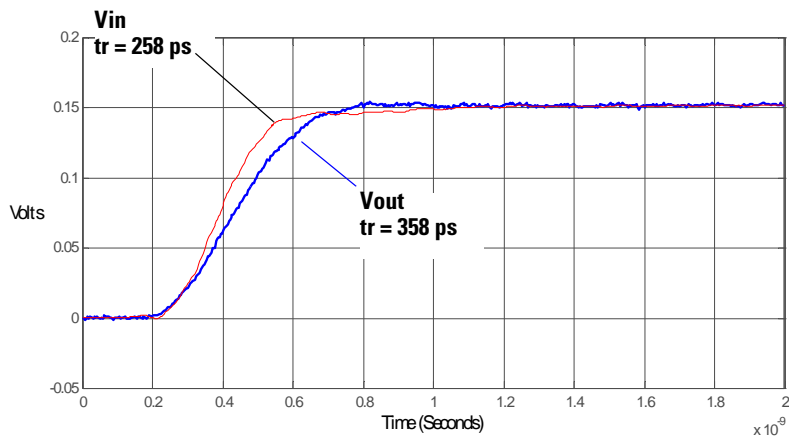
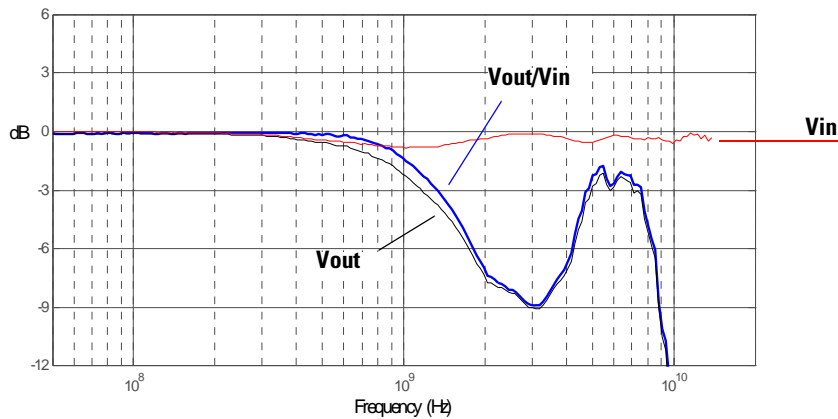


Figure 191 Graph of  $25\Omega$  240 ps step generator with and without probe connected.

**8 1134A Performance Data Plots**  
E2678A Differential Socketed Probe Head with Damped Wire Accessory

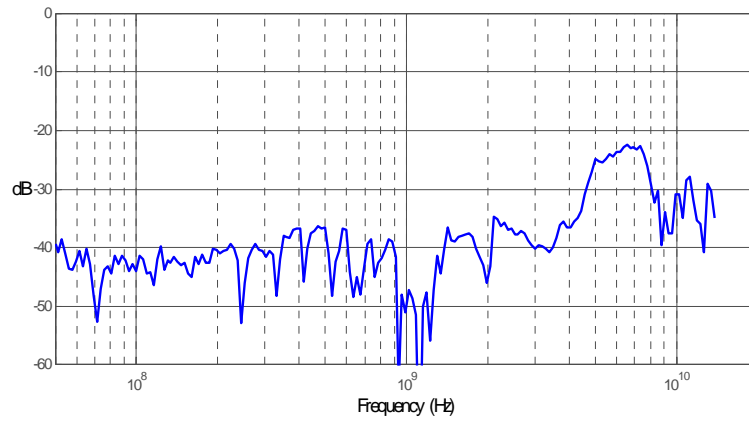


**Figure 192** Graph of  $V_{in}$  and  $V_{out}$  of probe with a  $25\Omega$  240 ps step generator.



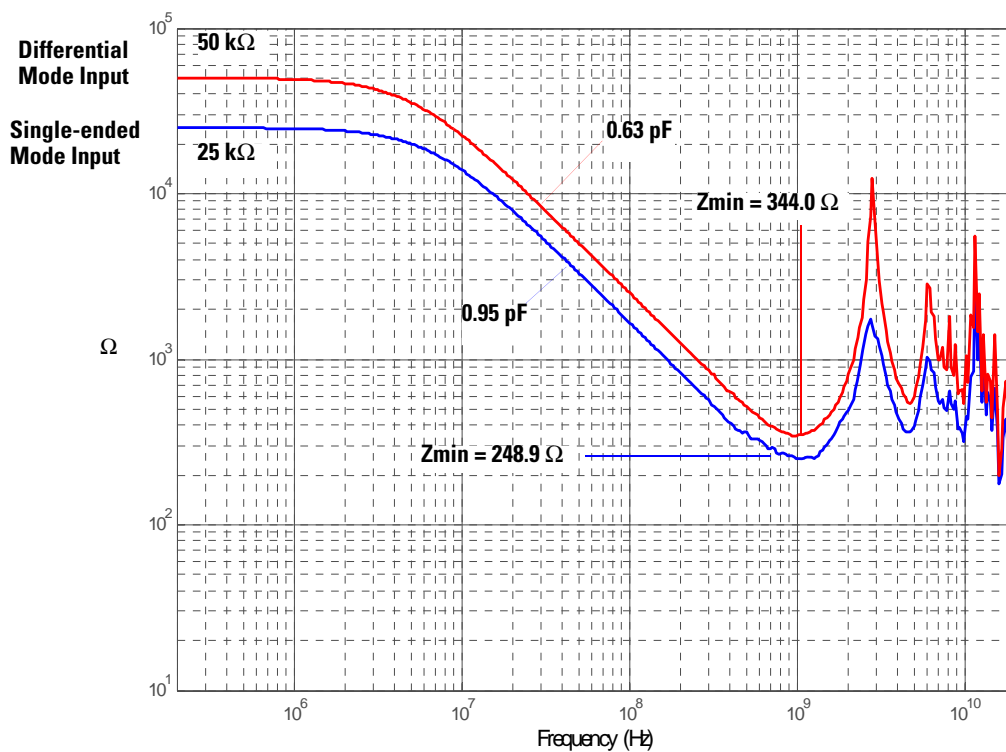
**Figure 193** Graph of  $V_{in}$  and  $V_{out}$  of probe with a  $25\Omega$  source and  $V_{out}/V_{in}$  frequency response.

## E2678A Differential Socketed Probe Head with Damped Wire Accessory



**Figure 194** Graph of V<sub>out</sub>/V<sub>in</sub> frequency response when inputs driven in common (common mode rejection).

**8 1134A Performance Data Plots**  
E2678A Differential Socketed Probe Head with Damped Wire Accessory



**Figure 195 Magnitude plot of probe input impedance versus frequency.**



## E2679A Single-Ended Solder-in Probe Head (Full BW)

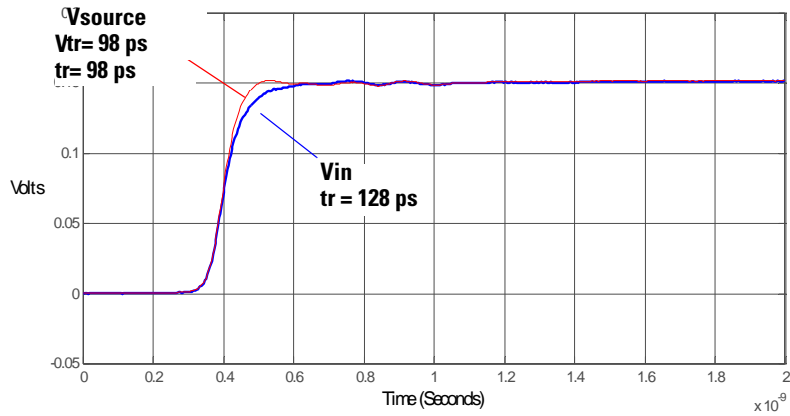


Figure 196 Graph of 25Ω 100 ps step generator with and without probe connected.

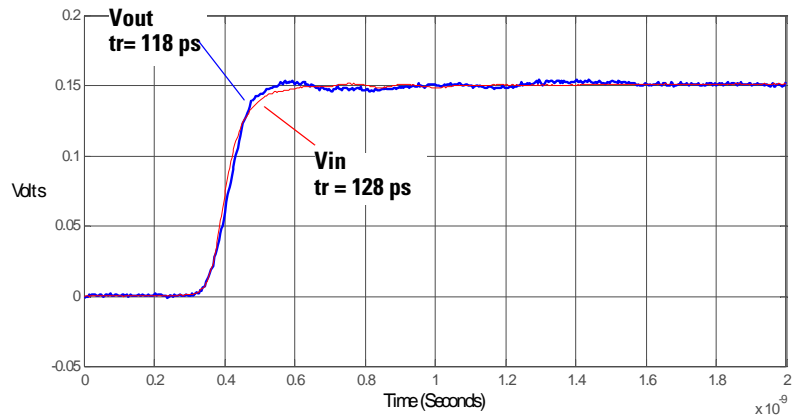
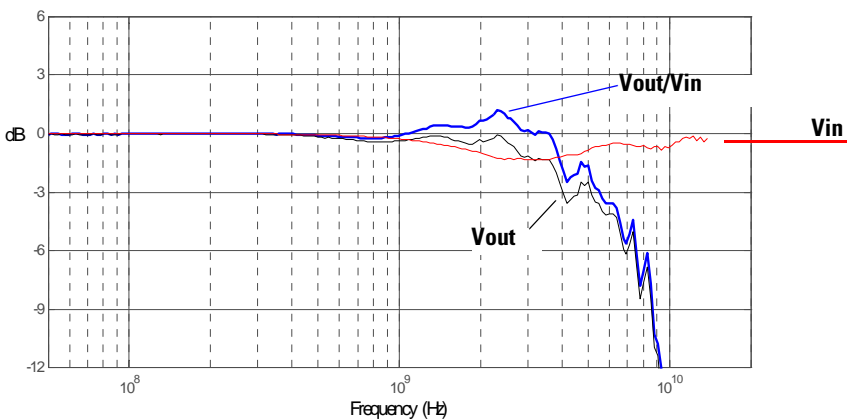
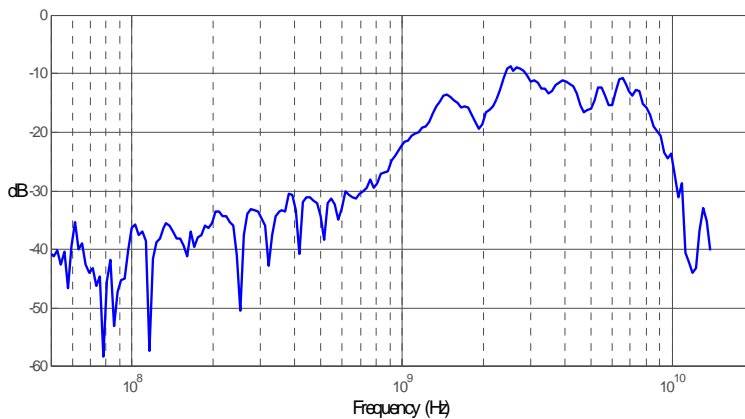


Figure 197 Graph of Vin and Vout of probe with a 25Ω 100 ps step generator.

**8 1134A Performance Data Plots**  
E2679A Single-Ended Solder-in Probe Head (Full BW)



**Figure 198** Graph of  $V_{in}$  and  $V_{out}$  of probe with a  $25\Omega$  source and  $V_{out}/V_{in}$  frequency response.



**Figure 199** Graph of  $V_{out}/V_{in}$  frequency response when inputs driven in common (common mode rejection).

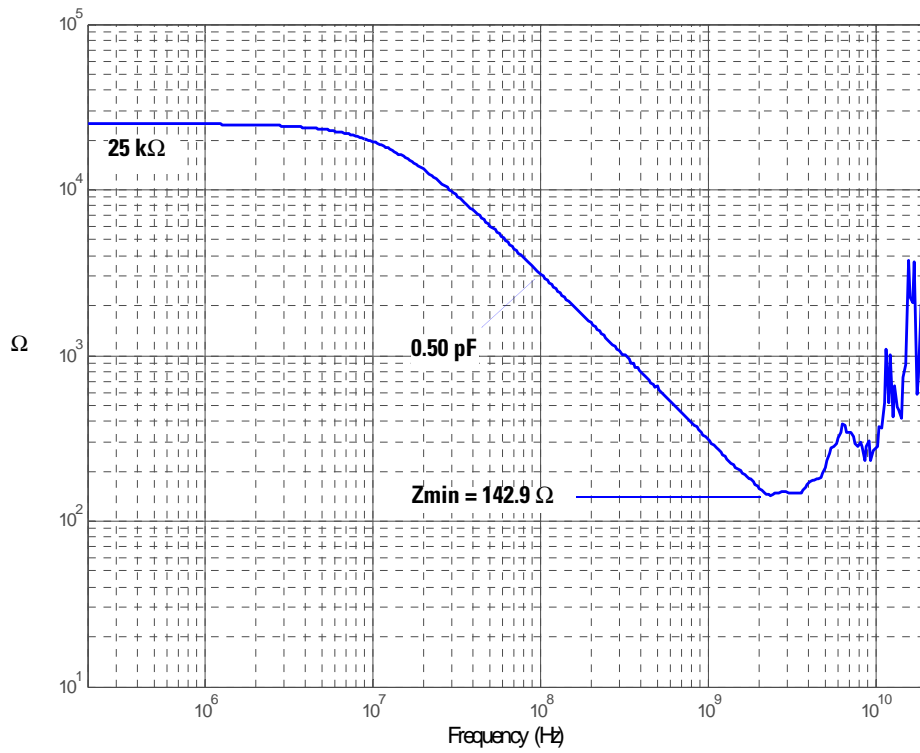


Figure 200 Magnitude plot of probe input impedance versus frequency.

## E2679A Single-Ended Solder-in Probe Head (Medium BW)

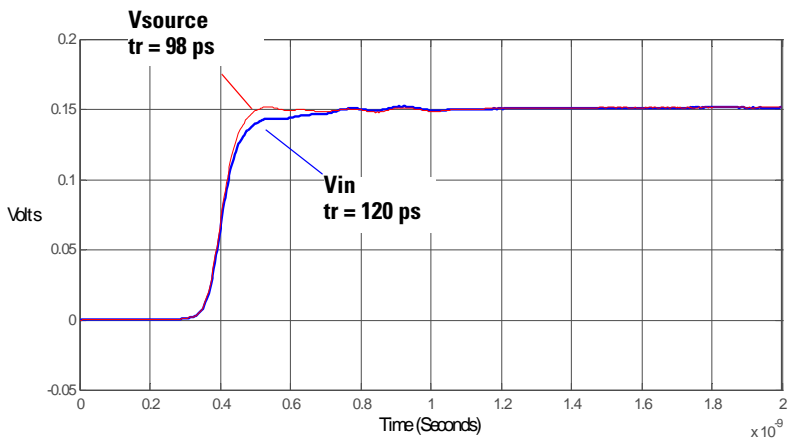


Figure 201 Graph of 25Ω 100 ps step generator with and without probe connected.

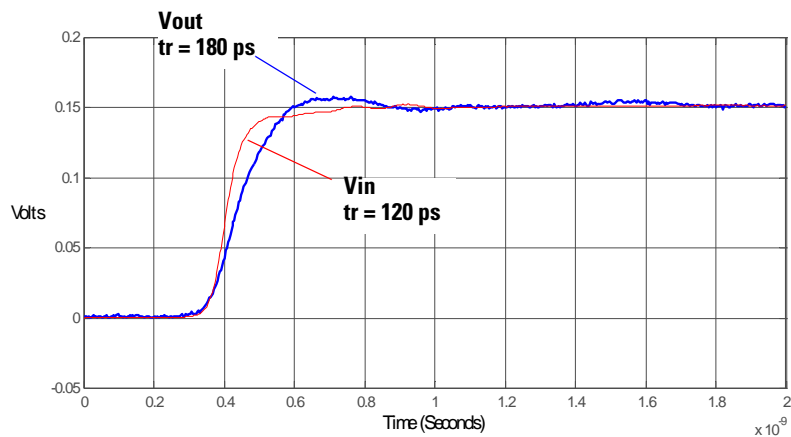


Figure 202 Graph of Vin and Vout of probe with a 25Ω 100 ps step generator.

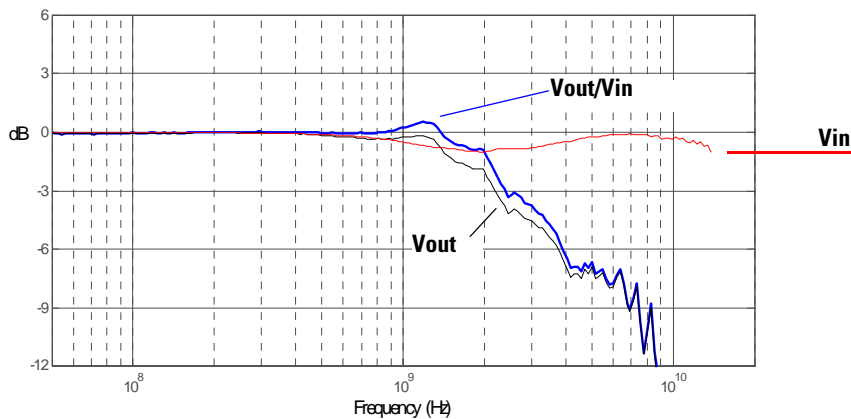


Figure 203 Graph of  $V_{in}$  and  $V_{out}$  of probe with a  $25\Omega$  source and  $V_{out}/V_{in}$  frequency response.

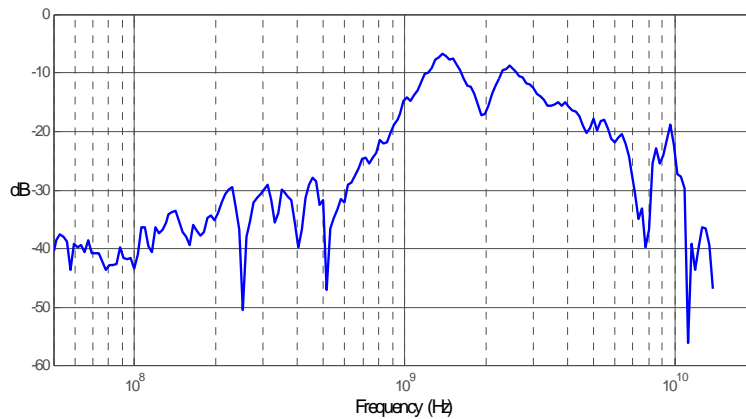
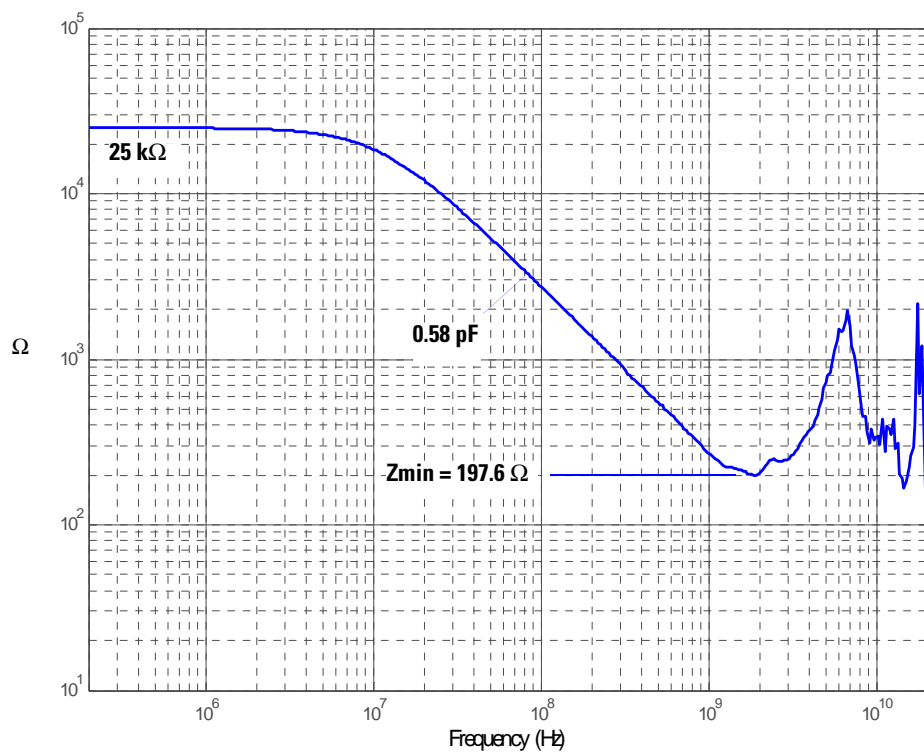


Figure 204 Graph of  $V_{out}/V_{in}$  frequency response when inputs driven in common (common mode rejection).

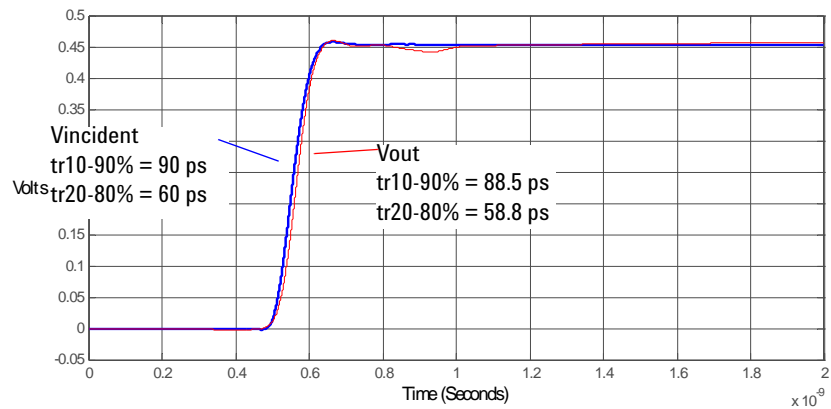
**8 1134A Performance Data Plots**  
**E2679A Single-Ended Solder-in Probe Head (Medium BW)**



**Figure 205 Magnitude plot of probe input impedance versus frequency.**

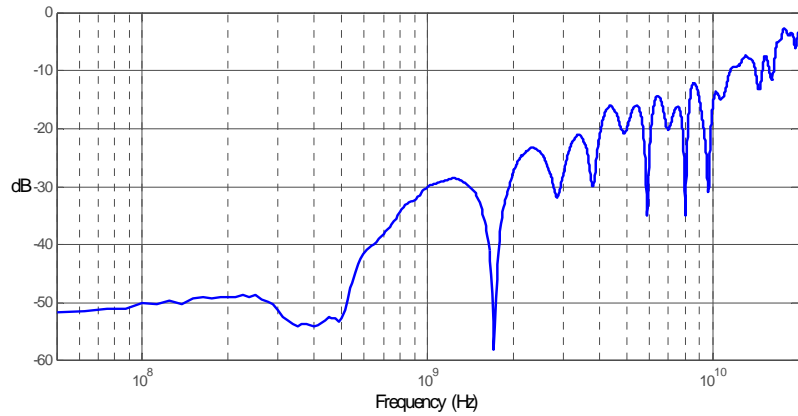
## N5380B SMA Probe Head

The following performance characteristic plots are for the 1134A probe using N5380B probe head. For a graph of the return loss, refer to the Performance Plots chapter in the 1168/9A User's Guide.

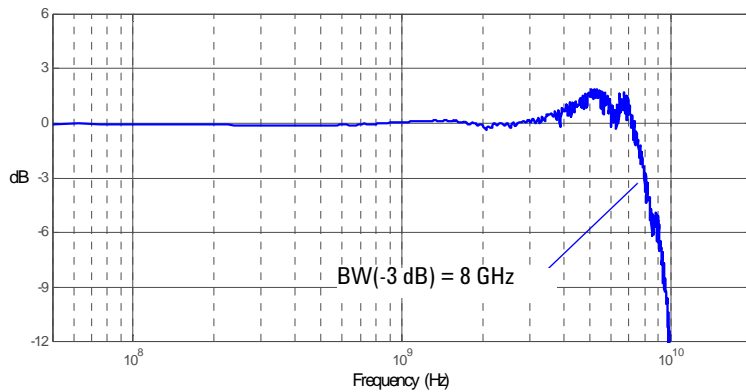


**Figure 206** Vincident and Vout of probe with a 90 ps step

**8 1134A Performance Data Plots**  
N5380B SMA Probe Head

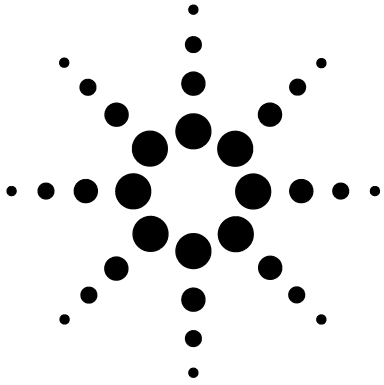


**Figure 207 Magnitude plot of differential return loss**



**Figure 208 Magnitude response of differential insertion loss +16.03 dB**





## 9

# Performance Verification

Using the 8720ES VNA successfully 203

Procedure 204

Performance Test Record 213

This chapter describes how to verify the bandwidth performance of the probe.

---

### CAUTION

Electrostatic discharge (ESD) can quickly and imperceptibly damage or destroy high performance probes, resulting in costly repairs. Always wear a wrist strap when handling probe components and ensure that cables are discharged before being connected.





---

### NOTE

Allow the probe to warm up for at least 20 minutes.

## 9 Performance Verification

**Table 27 Required Test Equipment**

| Test Equipment  | Critical Specification                       | Model Number  |
|---|--|---|
| Vector Network Analyzer (VNA)                           | 7 GHz sweep range full 2 port cal Option 1D5 | Agilent 8720ES<br>     |
| Calibration Standards                                   | No Substitute                                | Agilent 85052D  |
| External Power Supply                                   | No Substitute                                | Agilent 1143A<br>       |
| AutoProbe Interface Adapter                             | No Substitute                                | Agilent N1022A/B<br>   |
| Outside thread 3.5 mm (male) to 3.5 mm (female) adapter | No Substitute                                | Agilent 5062-1247   |
| Cable (2)   | 3.5 mil; SMA; High Quality                   | Agilent 8120-4948   |
| Cable   | 1.5 mil Probe Power Extension No Substitute  | Agilent 01143-61602   |
| PV Fixture  | E2655B/C, No Substitute                      | Agilent E2655B/C<br> |

## Using the 8720ES VNA successfully

Remember these simple guidelines when working with the 8720ES VNA during this procedure.

- Sometimes it may take a few seconds for the waveforms to settle completely. Allow time for waveforms to settle before continuing.
- Make sure all connections are tight and secure. If needed, use a vise to hold the cables and test board stable while making measurements.
- Be careful not to cross thread or force any connectors. This could be a very costly error to correct.

## Procedure

### Initial Setup

- 1 Turn on the 8720ES VNA and let warm up for 20 minutes.
- 2 Press the green **[Preset]** key on the 8720ES VNA.
- 3 On the VNA, press the **[Power]** key and set the power to 0 dBm.
- 4 On the VNA, press the **[AVG]** key and then select the **Averaging Factor** screen key. Set averaging to 4.
- 5 On the VNA, press the **[Sweep Setup]** key and then press the **sweep type menu** screen key. Select the **log freq** screen key.
- 6 Connect the probe under test to the Auto Probe Adapter and power the probe using the 1143A power supply. Install the outside thread adapter to the Auto Probe Adapter.

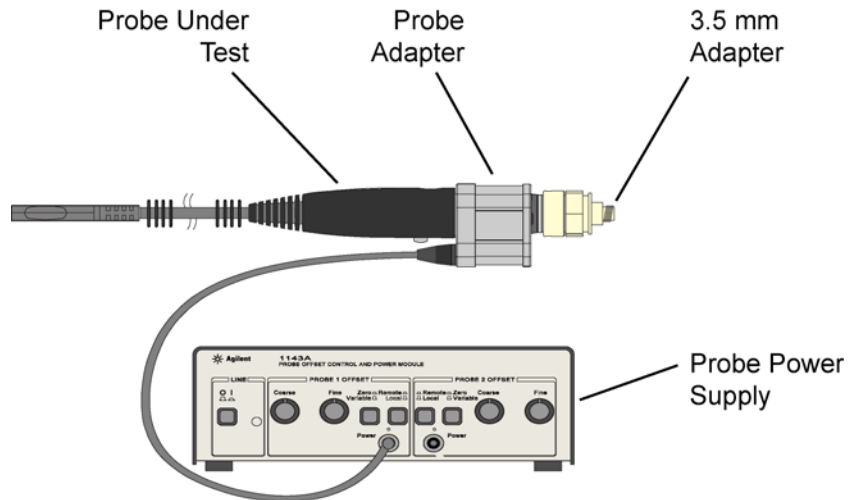
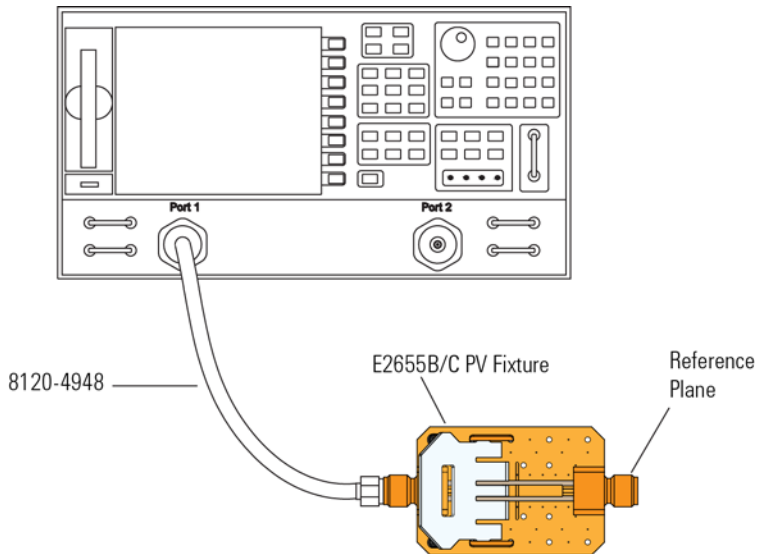


Figure 209 Probe Connected to Power Supply

### Calibrating a Reference Plane

To get a reliable measurement from the VNA you must calibrate a reference plane so that the VNA knows where the probe under test is located along the transmission line.

- 7** On the VNA, press the **[Cal]** key.
- 8** Press the **cal menu** screen key.
- 9** Press the **full 2 port** screen key.
- 10** Connect one of the high quality SMA cables from the VNA's **Port 1** to the pincher side of PV Fixture as shown in [Figure 210](#). The figure also identifies the calibration reference plane.

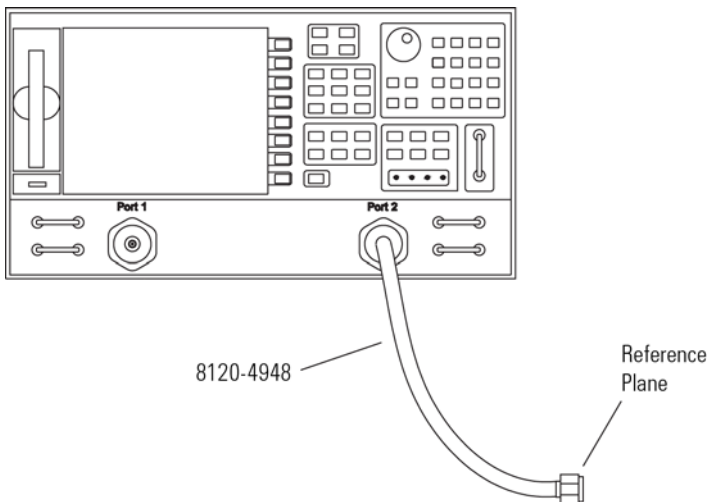


**Figure 210 PV Fixture Connected to VNA**

- 11** Perform a calibration at the reference plane:
  - a** Press the **reflection** screen key.
  - b** Connect the open end of 85052D Calibration Standard to the non-pincher side of the PV/DS test board.
  - c** Select the **open** screen key under the **Forward** group.

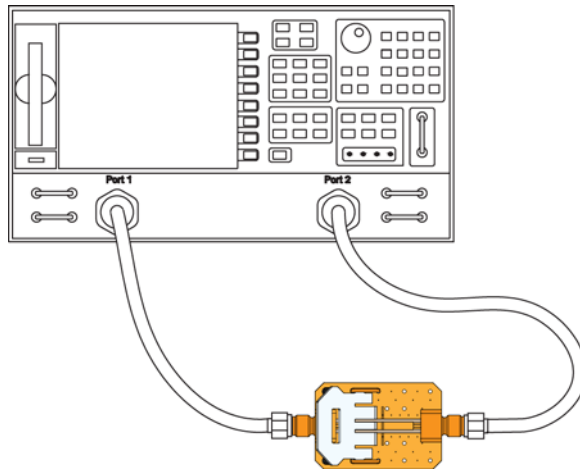
## 9 Performance Verification Procedure

- d** Wait until the VNA beeps indicating that it has completed the task.
  - e** Connect short end of Calibration Standard to the non-pincher side of the PV/DS test board.
  - f** Select **short** screen key under the **Forward** group.
  - g** Wait until the VNA beeps indicating that it has completed the task.
  - h** Connect load end of Calibration Standard to the non-pincher side of the PV/DS test board.
  - i** Select the **loads** screen key under the **Forward** group.
  - j** Press **broadband** screen key selection.
  - k** Wait until the VNA beeps indicating that it has completed the task.
  - l** Press the **done loads** screen key.
  - m** You have just calibrated one side of the reference plane.
- 12** Connect the other high quality SMA cable to the VNA's **PORT 2** connector.



**Figure 211 SMA Cable Connected to Port 2**

- 13 Get the opposite sex of the Calibration Standards for the next step.
- 14 Perform Calibration for the **PORT 2** side of the Reference plane.
  - a Press the **reflection** screen key.
  - b Connect the open end of Calibration Standard to the available end of the **PORT 2** SMA cable.
  - c Select the **open** screen key under the **Reverse** group.
  - d Wait until the VNA beeps indicating that it has completed the task.
  - e Connect short end of Calibration Standard to the available end of the **PORT 2** SMA cable.
  - f Select **short** screen key the **Reverse** group.
  - g Wait until the VNA beeps indicating that it has completed the task.
  - h Connect load end of Calibration Standard to the available end of the **PORT 2** SMA cable.
  - i Select the **loads** screen key the **Reverse** group.
  - j Press **broadband** screen key selection.
  - k Wait until the VNA beeps indicating that it has completed the task.
  - l Press the **done loads** screen key.
  - m You have just calibrated the other side of the reference plane.
- 15 Press **standards done** key.
- 16 Connect **PORT 2** SMA cable to the non-pincher side of PV Fixture.



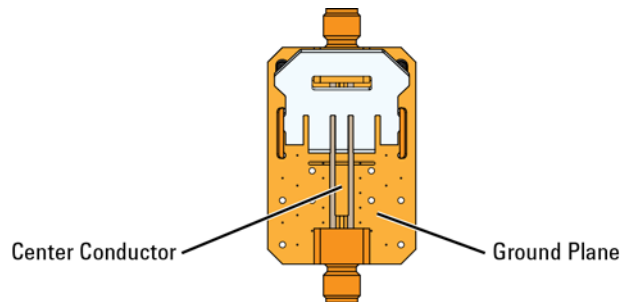
**Figure 212 Forward and Reverse Setup**

- 17 Press the **transmission** screen key.
- 18 Press the **do both fwd and reverse** screen key.
- 19 Wait until the VNA beeps four times indicating that it has completed the task.
- 20 Press the **isolation** screen key.
- 21 Press the **omit isolation** screen key.
- 22 Press **done 2 port cal** screen key.
- 23 Set the VNA's averaging to off.
- 24 Save the reference plane cal by pressing the [**save recall**] key then the [**save state**] key.
- 25 You may change name if you wish.
- 26 Press the [**scale reference**] key. Then set the scale to 1 dB per division and the reference position for 7 divisions.
- 27 Set reference value for 0 dB.
- 28 Press the [**measure**] key.
- 29 Press the **s21** screen key.
- 30 Ensure s21 response on screen is flat (about  $\pm 0.1$  dB) out to 10 GHz.



## Measuring Vin Response

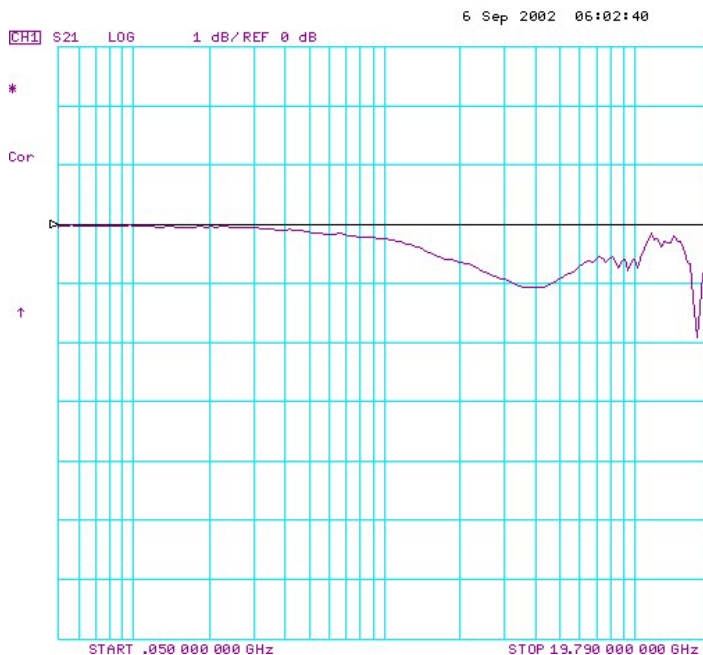
- 31 Position 1134A probe conveniently to make quality connections on the PV fixture.
- 32 Ensure resistors at the probe tip are reasonably straight and about 0.1 inches apart.
- 33 Connect probe tip under the PV fixture's pincher. Apply upward pressure to the clip to ensure a proper electrical connection. Place the probe's "+" side on center conductor and "-" side to ground as shown in the following figure.



**Figure 213 Probe Locations on PV Fixture**

- 34 Press the [**Sweep Setup**] key on the VNA. Then press the **trigger menu** screen key. Select the **continuous** screen key.
- 35 The  $V_{in}$  waveform shown on screen should be similar to that shown in [Figure 214](#).

## 9 Performance Verification Procedure



**Figure 214 Typical  $V_{in}$  Waveform for an 1134A Probe**

- 36** Select [**display**] key then **data->memory** screen key.
- 37** You have now saved  $V_{in}$  waveform into the VNA's memory for future use.

### Measuring $V_{out}$ Response

- 38** Disconnect the **PORT 2** cable from PV/DS test board and attach to probe output on the AutoProbe Adapter.
- 39** Connect the Calibration Standard load to PV/DS test board (non-pincher side).
- 40** Press [**scale reference**] key on the VNA.
- 41** Set reference value to  $-20$  dB.
- 42** Hold probe in place as described previously.

- 43 The display on screen is  $V_{out}$  and it should be similar to that shown in Figure 215.

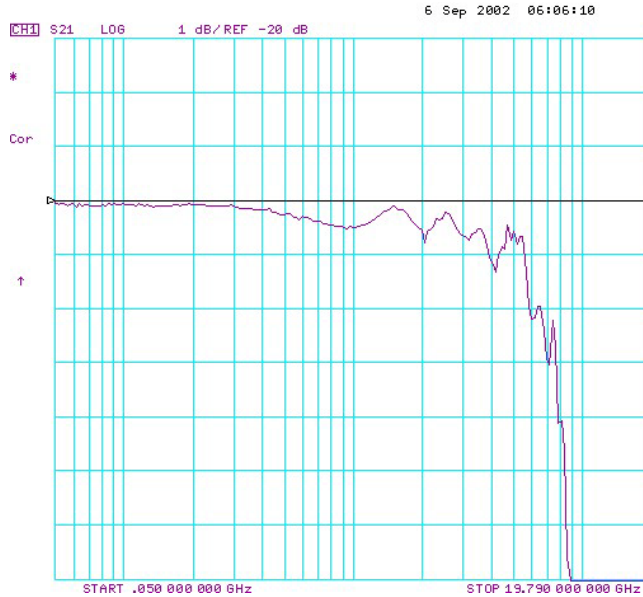
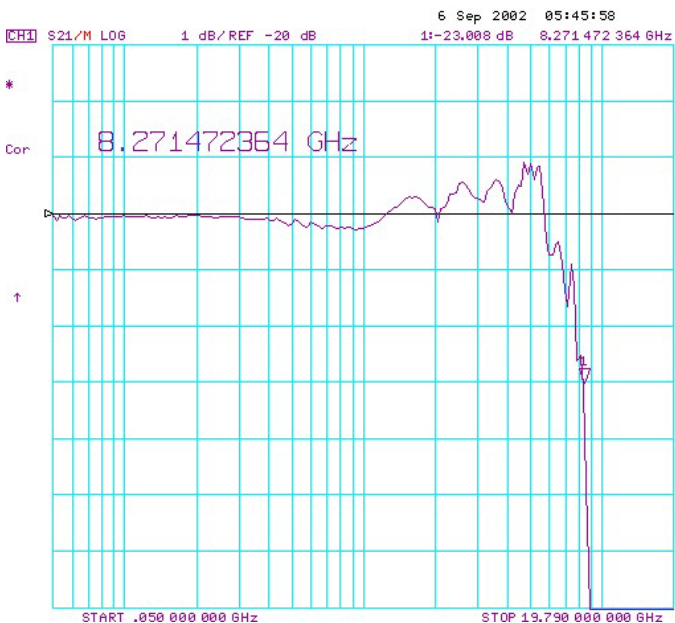


Figure 215 Typical  $V_{out}$  Waveform for an 1134A Probe

### Displaying the $V_{out}/V_{in}$ Response

- 44 Press the **[Display]** key.
- 45 Then select the **Data/Memory** screen key. You may need to adjust the **Reference Value**, located under the **Scale Ref** key, slightly to position the waveform at center screen. The waveform should be similar to that shown in Figure 216.

## 9 Performance Verification Procedure



**Figure 216 Typical Waveform for an 1134A Prob**

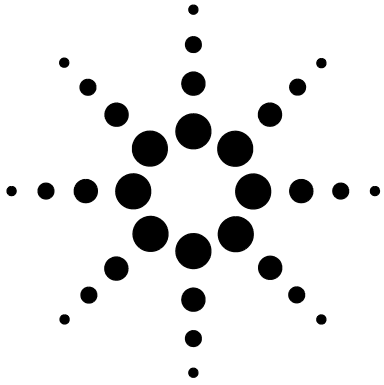
- 46 Press marker key and position the marker to the first point that the signal is -3 dB below center screen.
- 47 Read marker frequency measurement and record it in the test record located later in this chapter.
- 48 The bandwidth test passes if the frequency measurement is greater than the probe's bandwidth limit.

## Performance Test Record

**Table 28 Performance Test Record**

|                        |                    |                                    |                  |
|------------------------|--------------------|------------------------------------|------------------|
| <b>Model #:</b>        | <b>Date:</b>       | <b>Recommended next test date:</b> |                  |
| <b>Serial #:</b>       | <b>Tested by:</b>  |                                    |                  |
| <b>Probe Amplifier</b> | <b>Test Limits</b> | <b>Result</b>                      | <b>Pass/Fail</b> |
| 1130A                  | ≥ 1.5 GHz          |                                    |                  |
| 1131A                  | ≥ 3.5 GHz          |                                    |                  |
| 1132A                  | ≥ 5 GHz            |                                    |                  |
| 1134A                  | ≥ 7 GHz            |                                    |                  |

**9 Performance Verification**  
Performance Test Record



## 10 SPICE Models

|   |     |
|---|-----|
| SPICE Model for Differential Probe Heads      | 217 |
| SPICE Model for Single-Ended Probe Heads      | 219 |
| SPICE Deck and Measured/Modeled Data Matching | 220 |
| E2675A Differential Browser Probe Head        | 220 |
| E2678A Differential Socket Tip Probe Head     | 222 |
| E2677A Differential Solder-In Probe Head      | 224 |
| E2676A Single-Ended Browser Probe Head        | 226 |
| E2679A Single-Ended Solder-In Probe Head      | 228 |

### Input Impedance SPICE Models for InfiniiMax 1130 Series 3.5 GHz to 7 GHz Active Probes

This chapter contains SPICE models that can be used to predict the probe loading effects of the InfiniiMax active probes. Important points about these SPICE models are:

- SPICE models shown here are currently only for input impedance which allows modeling of the probe loading effects. Probe transfer function is generally flat to the specified BW. Transfer function SPICE models may be added later if demand is sufficient.
- These input impedance is a function of the probe head type only. The probe amp bandwidth (3.5GHz 1131A, 5GHz 1132A, or 7GHz 1134A) does not have any effect on the input impedance of the probe heads.

The following five configurations are covered in this chapter:

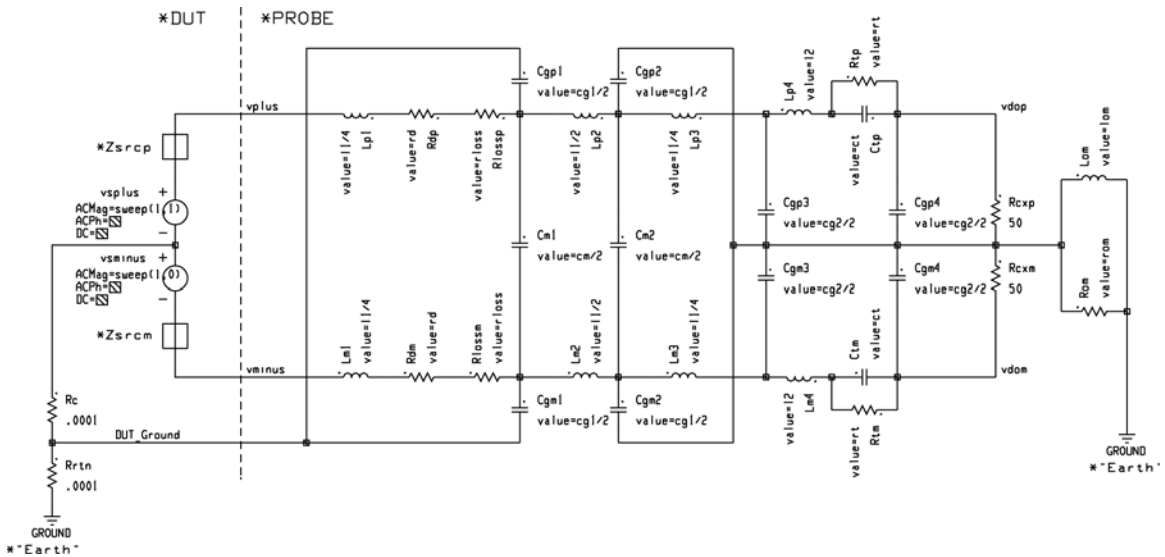
- Differential Browser Probe Head (E2675A)
- Differential Socket Tip Probe Head (E2678A)
- Differential Solder-In Probe Head (E2677A) (Full BW 91-ohm resistors)
- Single-Ended Browser Probe Head (E2676A)
- Single-Ended Solder-In Probe Head (E2679A) (Full BW 91-ohm resistor)

If damped wire accessories or longer mid-BW resistors (for solder-in probe heads) are used, they can be modeled by adding an RLC model in front of the appropriate probe head model and zeroing out the damping resistor in the probe head model.

There is one SPICE schematic for the differential probe heads and one SPICE schematic for the single-ended probe heads. The schematics have parameterized R, L, and C values that are given in the SPICE deck for the specific probe head. Additionally, an input impedance plot is given that shows the matching of the measured data to the modeled data. Matching is generally very good up to the specified BW of the probe head with the 7 GHz probe amp.



# SPICE Model for Differential Probe Heads



**Figure 217 SPICE Model for Differential Probe Heads**

Rrtn (Zrtn) is dependent on connection from DUT ground to “Earth” ground. Most likely modeled by a parallel RL similar to Rom || Lom. Will have slight effect on single-ended input Z and no effect on differential input Z.

Cgp1 and Cgm1 represent C from probe tips to DUT ground near probe tips.

If using diff probe to probe single-ended signals:

- vplus connected to DUT signal
- vminus connected to DUT ground with means that Rc = 0 and Zsrcm = 0.
- Input impedance is defined to be vplus/i (vsplus)

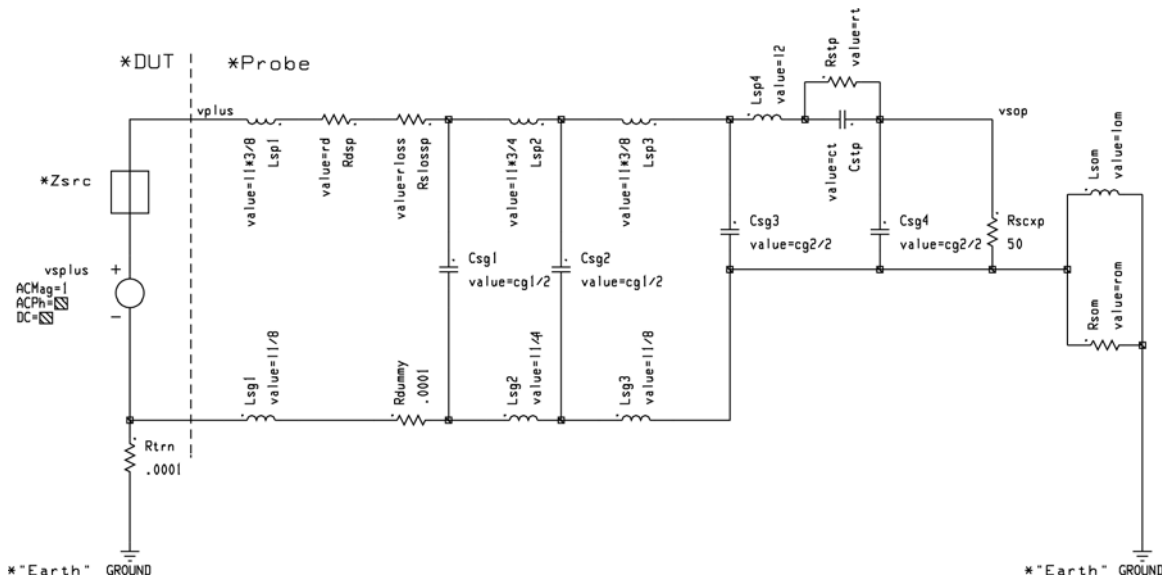
## 10 SPICE Models

### SPICE Model for Differential Probe Heads

If using diff probe to probe differential signals:

- $R_c$  (or  $Z_c$ ) will depend on the DUT circuit
- $v_{plus}$  connected to DUT plus signal
- $v_{minus}$  connected to DUT minus signal.
- Input impedance is defined to be  $(v_{plus}/v_{minus}) / i_{(vsplus)}$

# SPICE Model for Single-Ended Probe Heads



**Figure 218 SPICE Model for Single-Ended Probe Heads**

Rtn (Zrtn) is dependent on connection from DUT ground to “Earth” ground. Most likely modeled by a parallel RL similar to Rom || Lom. Will have slight effect on input Z.

Probe tip C to DUT ground lumped into Csg1 since there is no damping R in ground path.

Input impedance is defined as  $vplus/i(vplus)$ .

## SPICE Deck and Measured/Modeled Data Matching

### E2675A Differential Browser Probe Head



```
.param rd=91 rt=25k rloss=10 rom=100 l1=6.5n l2=2n lom=2u
cm=80f cg1=120f cg2=320f ct=200f
```

```
vsminus %164 %vminus ACMag=sweep(1,0)
vsplus %vplus %164 ACMag=sweep(1,1)
Cgp1 %DUT_Ground %99 value=cg1/2
Cgp2 %122 %85 value=cg1/2
Cgm2 %84 %122 value=cg1/2
Cgm1 %95 %DUT_Ground value=cg1/2
Cm1 %99 %95 value=cm/2
Cgp3 %86 %122 value=cg2/2
Cm2 %85 %84 value=cm/2
Cgm4 %122 %vdom value=cg2/2
Cgm3 %122 %87 value=cg2/2
Cgp4 %vdop %122 value=cg2/2
Ctp %vdop %88 value=ct
Ctm %89 %vdom value=ct
Lm3 %84 %87 value=l1/4
Lp3 %86 %85 value=l1/4
Lm4 %89 %87 value=l2
Lp4 %86 %88 value=l2
Lp1 %118 %vplus value=l1/4
Lp2 %85 %99 value=l1/2
Lm1 %vminus %117 value=l1/4
Lm2 %95 %84 value=l1/2
Lom %122 %0 value=lom
Rrtn %DUT_Ground %0 .0001
Rc %164 %DUT_Ground .0001
Rlossp %99 %159 value=rloss
Rlossm %160 %95 value=rloss
Rdp %159 %118 value=rd
Rdm %117 %160 value=rd
Rtm %vdom %89 value=rt
Rtp %88 %vdop value=rt
Rcxp %vdop %122 50
Rcxm %122 %vdom 50
Rom %122 %0 value=rom
```



## 10 SPICE Models

### SPICE Deck and Measured/Modeled Data Matching

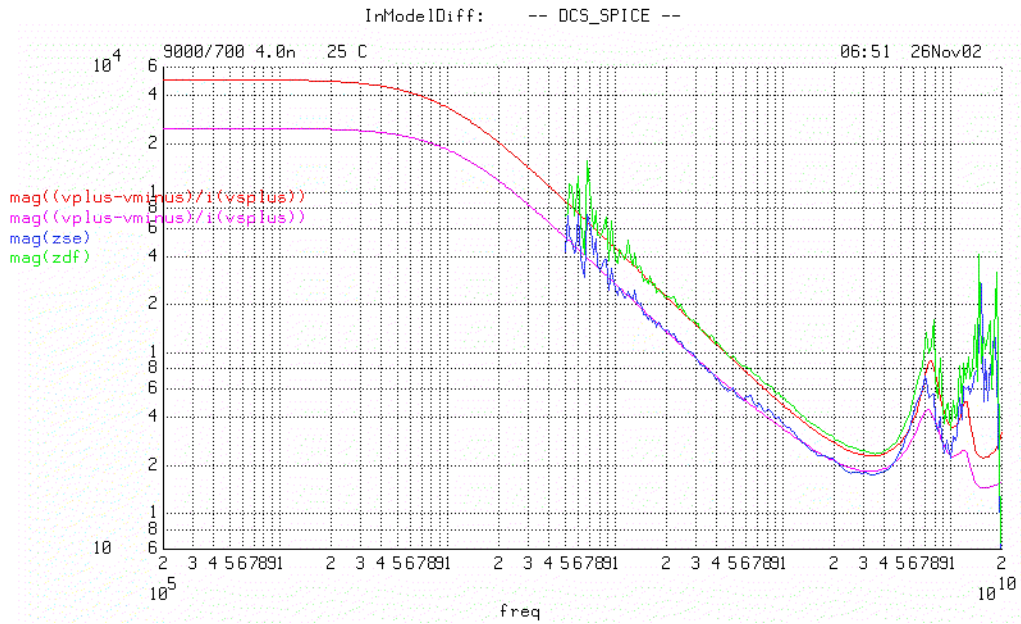
#### E2678A Differential Socket Tip Probe Head



```
.param rd=82 rt=25k rloss=25 rom=200 l1=4n l2=2n lom=2u  
cm=117f cg1=120f cg2=320f ct=200f
```

```
vsminus %164 %vminus ACMag=sweep(1,0)  
vsplus %vplus %164 ACMag=sweep(1,1)  
Cgp1 %DUT_Ground %99 value=cg1/2  
Cgp2 %122 %85 value=cg1/2  
Cgm2 %84 %122 value=cg1/2  
Cgm1 %95 %DUT_Ground value=cg1/2  
Cm1 %99 %95 value=cm/2  
Cgp3 %86 %122 value=cg2/2  
Cm2 %85 %84 value=cm/2  
Cgm4 %122 %vdom value=cg2/2  
Cgm3 %122 %87 value=cg2/2  
Cgp4 %vdop %122 value=cg2/2  
Ctp %vdop %88 value=ct  
Ctm %89 %vdom value=ct  
Lm3 %84 %87 value=l1/4  
Lp3 %86 %85 value=l1/4  
Lm4 %89 %87 value=l2  
Lp4 %86 %88 value=l2  
Lp1 %118 %vplus value=l1/4  
Lp2 %85 %99 value=l1/2  
Lm1 %vminus %117 value=l1/4  
Lm2 %95 %84 value=l1/2  
Lom %122 %0 value=lom  
Rrtn %DUT_Ground %0 .0001  
Rc %164 %DUT_Ground .0001  
Rlossp %99 %159 value=rloss  
Rlossm %160 %95 value=rloss  
Rdp %159 %118 value=rd  
Rdm %117 %160 value=rd  
Rtm %vdom %89 value=rt  
Rtp %88 %vdop value=rt  
Rcxp %vdop %122 50  
Rcxm %122 %vdom 50  
Rom %122 %0 value=rom
```

SPICE Deck and Measured/Modeled Data Matching



## 10 SPICE Models

### SPICE Deck and Measured/Modeled Data Matching

#### E2677A Differential Solder-In Probe Head



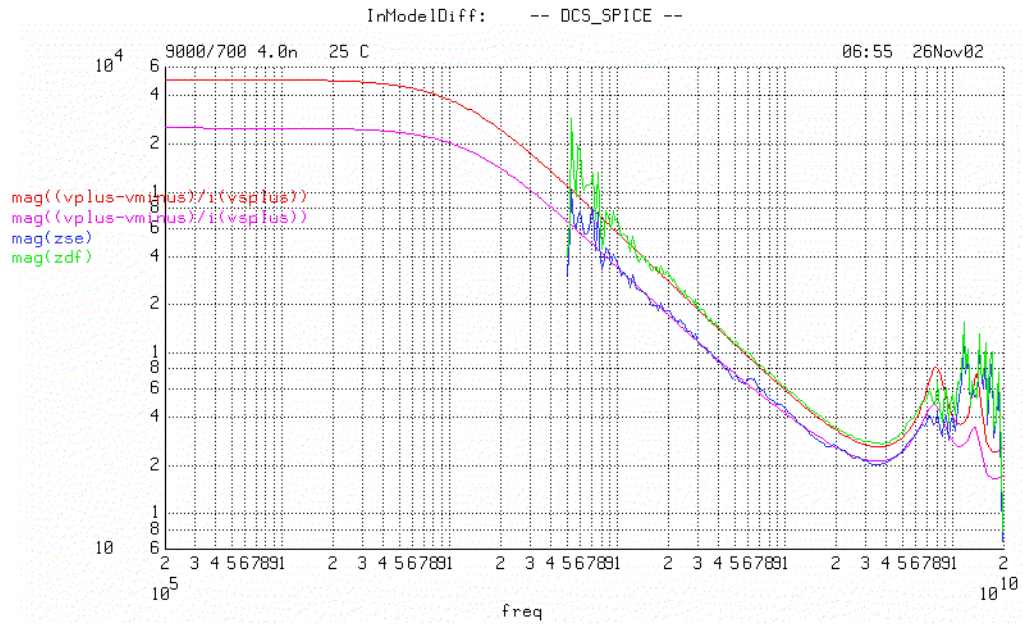
Data for full bandwidth with 91Ω resistor.

```
.param rd=91 rloss=18 rt=25k rom=250 l1=4n l2=2n lom=2u
cm=100f cg1=80f cg2=180f ct=200f

vsminus %164 %vminus ACMag=sweep(1,0)
vsplus %vplus %164 ACMag=sweep(1,1)
Cgp1 %DUT_Ground %99 value=cg1/2
Cgp2 %122 %85 value=cg1/2
Cgm2 %84 %122 value=cg1/2
Cgm1 %95 %DUT_Ground value=cg1/2
Cm1 %99 %95 value=cm/2
Cgp3 %86 %122 value=cg2/2
Cm2 %85 %84 value=cm/2
Cgm4 %122 %vdom value=cg2/2
Cgm3 %122 %87 value=cg2/2
Cgp4 %vdop %122 value=cg2/2
Ctp %vdop %88 value=ct
Ctm %89 %vdom value=ct
Lm3 %84 %87 value=l1/4
Lp3 %86 %85 value=l1/4
Lm4 %89 %87 value=l2
Lp4 %86 %88 value=l2
Lp1 %118 %vplus value=l1/4
Lp2 %85 %99 value=l1/2
Lm1 %vminus %117 value=l1/4
Lm2 %95 %84 value=l1/2
Lom %122 %0 value=lom
Rrtn %DUT_Ground %0 .0001
Rc %164 %DUT_Ground .0001
Rlossp %99 %159 value=rloss
Rlossm %160 %95 value=rloss
Rdp %159 %118 value=rd
Rdm %117 %160 value=rd
Rtm %vdom %89 value=rt
Rtp %88 %vdop value=rt
Rcxp %vdop %122 50
Rcxm %122 %vdom 50
Rom %122 %0 value=rom
```



SPICE Deck and Measured/Modeled Data Matching



## 10 SPICE Models

### SPICE Deck and Measured/Modeled Data Matching

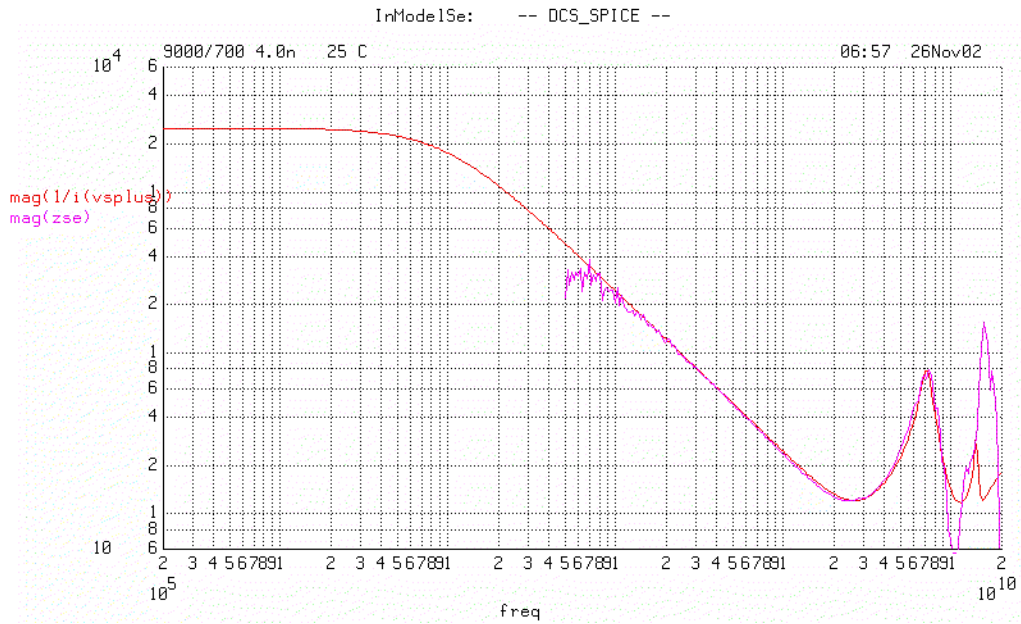
#### E2676A Single-Ended Browser Probe Head



```
.param rd=82 rt=25k rom=100 rloss=25 l1=3.5n l2=.5n lom=2u
cg1=270f cg2=370f ct=200f

.ac dec 77 200k 19.7g
.options map
vsplus %130 %165 ACMag=1
Csg4 %vsop %134 value=cg2/2
Cstp %vsop %131 value=ct
Csg2 %138 %139 value=cg1/2
Csg3 %132 %134 value=cg2/2
Csg1 %137 %136 value=cg1/2
Lsp1 %141 %130 value=l1*3/8
Lsp2 %138 %137 value=l1*3/4
Lsg1 %165 %164 value=l1/8
Lsg2 %136 %139 value=l1/4
Lsom %134 %0 value=lom
Lsp4 %132 %131 value=l2
Lsp3 %132 %138 value=l1*3/8
Lsg3 %139 %134 value=l1/8
Rtrn %165 %0 .0001
Rdummy %164 %136 .0001
Rslossp %137 %161 value=rloss
Rdsp %161 %141 value=rd
Rstp %131 %vsop value=rt
Rscxp %vsop %134 50
Rsom %134 %0 value=rom
```

SPICE Deck and Measured/Modeled Data Matching



## 10 SPICE Models

### SPICE Deck and Measured/Modeled Data Matching

#### E2679A Single-Ended Solder-In Probe Head



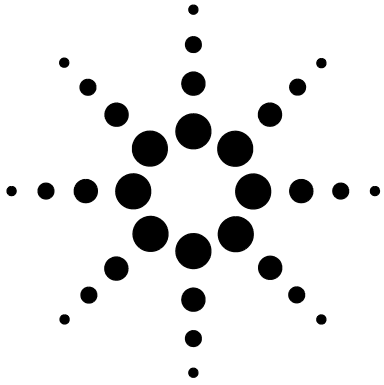
Data for full bandwidth with 91Ω resistor.

```
.param rd=91 rt=25k rom=250 rloss=25 l1=3n l2=.5n lom=2u
cg1=150f cg2=300f ct=200f

.ac dec 77 200k 19.7g
.options map
vsplus %130 %165 ACMag=1
Csg4 %vsop %134 value=cg2/2
Cstp %vsop %131 value=ct
Csg2 %138 %139 value=cg1/2
Csg3 %132 %134 value=cg2/2
Csg1 %137 %136 value=cg1/2
Lsp1 %141 %130 value=l1*3/8
Lsp2 %138 %137 value=l1*3/4
Lsg1 %165 %164 value=l1/8
Lsg2 %136 %139 value=l1/4
Lsom %134 %0 value=lom
Lsp4 %132 %131 value=l2
Lsp3 %132 %138 value=l1*3/8
Lsg3 %139 %134 value=l1/8
Rtrn %165 %0 .0001
Rdummy %164 %136 .0001
Rslossp %137 %161 value=rloss
Rdsp %161 %141 value=rd
Rstp %131 %vsop value=rt
Rscxp %vsop %134 50
Rsom %134 %0 value=rom
```



**10 SPICE Models**  
SPICE Deck and Measured/Modeled Data Matching



## 11

# Replacement Parts

|  |     |
|--|-----|
| E2675A Differential Browser Probe Head   | 232 |
| E2677A Differential Solder-In Probe Head | 232 |
| E2678A Differential Socketed Probe Head  | 233 |
| E2679A Single-Ended Solder-in Probe Head | 234 |
| Other Accessories                        | 234 |

## E2675A Differential Browser Probe Head

**Table 29 E2658A Kit**

| Description               | Qty Supplied |
|---------------------------|--------------|
| Resistive tip (blue), 91Ω | 20           |
| Ergonomic handle          | 1            |

## E2677A Differential Solder-In Probe Head

**Table 30 E2670A Kit**

| Description                        | Qty Supplied |
|------------------------------------|--------------|
| 91Ω resistor for full bandwidth    | 20           |
| 150Ω resistor for medium bandwidth | 10           |
| 91Ω resistor template              | 1            |
| 150Ω resistor template             | 1            |

**Table 31 Resistors**

| Description    | Qty | Order From Vendor  | Orderable Part Number |
|----------------|-----|--------------------|-----------------------|
| 91Ω resistor   | 1   | BREL International | RMB16-910-JB          |
| 150 Ω resistor | 1   | BREL International | RMB16A-151-JB         |



## E2678A Differential Socketed Probe Head

**Table 32 E2671A Kit**

| Description   | Qty Supplied |
|---|--------------|
| 160Ω damped wire accessory  | 6            |
| 82Ω resistor for full bandwidth                                   | 48           |
| Socket for 25 mil (25/1000 inch) square pins, female on both ends | 4            |
| 25 mil female socket w/20 mil round male pin on other end         | 4            |
| Heatshrink socket accessory                                       | 4            |
| Header adapter, 91Ω   | 2            |
| 82Ω resistor template   | 1            |

**Table 33 Resistors**

| Description  | Qty | Order From Vendor | Orderable Part Number |
|--------------|-----|-------------------|-----------------------|
| 82Ω resistor | 1   | Vishay            | MBA0204AC8209GC100    |

## 11 Replacement Parts

### E2679A Single-Ended Solder-in Probe Head

---

## E2679A Single-Ended Solder-in Probe Head

**Table 34 Resistors**

| Description          | Qty | Order From Vendor  | Orderable Part Number |
|----------------------|-----|--------------------|-----------------------|
| 0 $\Omega$ resistor  | 1   | BREL International | RMB16-000-JB          |
| 91 $\Omega$ resistor | 1   | BREL International | RMB16-910-JB          |

---

## Other Accessories

**Table 35 Accessories**

| Description   | Vendor                         | Part Number                      | Qty |
|---|--------------------------------|----------------------------------|-----|
| Probe deskew and performance verification kit                                 | Agilent                        | E2655C                           | 1   |
| 160 $\Omega$ damped wire accessory (01130-21302 34 each)                      | Agilent                        | E5381-82103                      | 1   |
| Header adapter kit for socketed differential probe head (01130-63201 10 each) | Agilent                        | 01131-68703                      | 1   |
| Coupling tag for N5450B extreme temperature cable extension                   | Agilent                        | N5450-21201                      | 1   |
| SMA coaxial dc block  | Inmet                          | #8037                            | 1   |
| SMA 6 dB coaxial attenuator   | Inmet                          | #18AH-6                          | 1   |
| SMA 12 dB coaxial attenuator  | Inmet                          | #18AH-12                         | 1   |
| SMA adjustable delay  | ATM Microwave                  | #P1907                           | 1   |
| GPO-F to GPO-F adaptor for N5380B   | Corning Gilbert<br>Rosenberger | #A1A1-0001-03<br>#19K 109-K00 E4 | 2   |

# Index

## A

accessories, 12  
 damped wire, 67  
 supplied, 12  
 Agilent Technologies, contacting, 44  
 altitude, 92  
 available probe heads, 9

## B

browser, differential, 53  
 browser, single-ended, 61

## C

calibration  
 failure, 42  
 probe, 77  
 calibration, probe with oscilloscope, 77  
 CAT definitions, 93  
 channel identification rings, 10  
 characteristics, 92  
 cleaning the probe, 10

## D

damped wire accessory, 67  
 definitions, CAT, 93  
 differential probe head, 69  
 dimensions, 92  
 probe amp, 94

## E

E2668A Single-Ended Connectivity Kit, 17  
 E2669A Differential Connectivity Kit, 19  
 E2675A Differential Browser Probe  
 Head, 13, 53

E2676A Single-Ended Browser Probe  
 Head, 14, 61  
 E2677A Differential Solder-In Probe  
 Head, 14, 48, 63  
 E2678A Differential Socketed Probe  
 Head, 15, 50, 67, 69  
 E2679A Single-Ended Solder-In Probe  
 Head, 16, 59, 65  
 environmental conditions, 92  
 ESD tolerance, 91  
 extreme temp, 22

## F

full bandwidth probe, 48, 50, 59

## G

general characteristics, 92

## H

header adapter, 69  
 humidity, 92

## I

Infiniium oscilloscope, 10  
 InfiniiVision oscilloscope, 10  
 inspecting, 11

## M

medium bandwidth, 63, 65

## N

N2880A InfiniiMax In-Line Attenuator, 24  
 N2881A InfiniiMax DC Blocking Caps, 28

N5380B, 56  
 N5425A ZIF Probe Head, 16  
 N5426A ZIF Tip, 16  
 N5450B cable, 22

## O

offset, 34  
 operating environment, 92  
 oscilloscope  
 compatible, 10  
 Infiniium, 10  
 InfiniiVision, 10

## P

performance verification, 201  
 pollution degree, 92  
 power requirements, 92  
 probe  
 cleaning, 10  
 dimensions, 94  
 handling, 30  
 inspecting, 11  
 offset, 34  
 service, 43  
 probe amplifier, 32  
 probe cable, 31  
 probe calibration, 77  
 probe handling, 30  
 probe heads  
 disconnecting, 30

## R

returning for service, 43

## Index

### S

safety, 39  
Safety Considerations, 39  
safety warnings, 39  
slew rate requirements, 36  
slew rates, 36  
socketed differential probe, 50, 67  
solder-in differential, 48  
solder-in differential probe, 63  
solder-in single-ended probe, 59, 65  
specifications, 89, 215

### T

temperature, 92  
temperature chamber, 22  
temperature ranges, 23

### V

velcro dots, 21

### W

WEEE compliance, 93  
weight, 92